

1999

An introduction of port state control in Vietnam

Minh Duc Tran
World Maritime University

Follow this and additional works at: http://commons.wmu.se/all_dissertations



Part of the [Admiralty Commons](#)

Recommended Citation

Tran, Minh Duc, "An introduction of port state control in Vietnam" (1999). *World Maritime University Dissertations*. 337.
http://commons.wmu.se/all_dissertations/337

This Dissertation is brought to you courtesy of Maritime Commons. Open Access items may be downloaded for non-commercial, fair use academic purposes. No items may be hosted on another server or web site without express written permission from the World Maritime University. For more information, please contact library@wmu.se.



WORLD MARITIME UNIVERSITY
Malmö, Sweden



**AN INTRODUCTION OF
PORT STATE CONTROL IN VIETNAM**

By

TRAN MINH DUC
Socialist Republic of Vietnam

A dissertation submitted to the World Maritime University in partial
fulfilment of the requirements for the award of the degree of

MASTER OF SCIENCE

in

MARITIME SAFETY AND ENVIRONMENTAL PROTECTION
Administration Specialisation

1999

DECLARATION

I certify that all the material in this dissertation that is not my own work has been identified, and that no material is included for which a degree has previously been conferred on me.

The contents of this dissertation reflect my own personal views, and are not necessarily endorsed by the University.

.....
20 August 1999
.....

Supervised by: Mr Jan Åke Jönsson
Associate Professor
Maritime Safety and Environmental Protection Course
World Maritime University

Assessed by: Mr Dick Hodgson
Associate Professor
Maritime Safety and Environmental Protection Course
World Maritime University

Co-Assessed by: Mr Tom Evers
Senior Ship Surveyor
Swedish Maritime Administration

ACKNOWLEDGEMENT

This dissertation is prepared during the two-year study at WMU, which is the result of the personal effort and the limitless support of various organisations and individuals. I would like to take this opportunity to express appreciation to these organisations and individuals for their contributions.

My deepest gratitude goes to

The Global Foundation for Research and Scholarship (GFRS) for granting me the two-year scholarship, without which my dream of studying in the World Maritime University (WMU) would not come true

Mr Nguyen Bao Son, Director General of Vietnam Marine Petroleum Transport and Supply Company (MAPETRANSCO) for his nomination for the course

Mr Nguyen Kim Viet, Deputy Manager of the Department for ISM Certification, Vietnam Register (VR), for his co-nomination, and his advice and encouragement during the two years in the WMU

My parents, my brother, my wife and Thuy Duong--my little daughter--for their endless love and encouragement

I also want to express my special thank to

Mr Jan Åke Jönsson, Associate Professor, Maritime Safety and Environmental Protection Course, World Maritime University for his supervising this dissertation

Mr. Dick Hodgson, Associate Professor of Maritime Safety and Environmental Protection Course, World Maritime University, for his assessing this dissertation

Mr. Tom Evers, Senior Ship Surveyor of Swedish Maritime Administration, for his co-assessing this dissertation

Ms. Jeanne Ott, English Instructor, for her assistance during IELP program and her correction of this dissertation

People who work at WMU for their effort in organising lectures, field studies, and providing the enjoyable stay in Malmö

My friends in Vietnam and in the WMU for their support and encouragement

ABSTRACT

Title of Dissertation: **An Introduction of Port State Control in Vietnam**

Degree: **MSc**

This dissertation is a study of the port State control mechanism and performance of the Vietnamese maritime administration in respect of port State control implementation.

By various methodologies the port State control mechanism is reviewed in a transparent way. The dissertation examines the characteristics of port State jurisdiction and examines the responsibilities of each party involved in implementation of port State control procedures. A brief look of regional MOUs is presented. The study further compares two MOUs--the Paris MOU and the Tokyo MOU--to give readers a more specific picture of the Tokyo MOU.

The Vietnamese maritime administration is reviewed from overall framework to performance of some specific bodies, like the VINAMARINE and the VR. Some analyses are also made in certain important areas. Then the study points out the problem areas in the Vietnamese maritime administration which are not only affecting port State control implementation but also flag State exercises.

The Chapter 5, Conclusions and Recommendations, examines the results of the study. Recommendations are made toward improving the effectiveness of the Vietnamese maritime administration and in particular improving port State control implementation which has started recently.

KEYWORDS: VINAMARINE, port State control, classification society, Tokyo MOU, Inspection, Vietnamese maritime administration.

TABLE OF CONTENTS

Declaration	ii
Acknowledgements	iii
Abstract	v
Table of Contents	vi
List of Tables	ix
List of Figures	x
Glossary of Terms	xi
1 Introduction	1
1.1 Necessity of Dissertation	1
1.2 Objectives	3
1.3 Scope	3
1.4 Methodology	4
1.5 Difficulties	5
2 Background to Port State Control	6
2.1 General	6
2.1.1 What is Port State Control?	6
2.1.2 Why Port State Control needs to be Introduced and Expanded?	7
2.1.3 Port State Enforcement Regime	8
2.1.4 Port State Control Framework	11
2.1.4.1 Responsibilities and Obligations of Flag State	12
2.1.4.2 Responsibilities and Obligations of Port State	13
2.1.4.3 Identification of Substandard Ships	14
2.1.4.4 No More Favourable Treatment	14
2.1.5 Regional PSC Agreements	15
2.2 Tokyo MOU	16
2.2.1 Development of the Tokyo MOU	17

2.2.1.1	Why Vietnam Not a Member of Tokyo MOU PSCC from Beginning?	18
2.2.2	Tokyo MOU in Comparison with Paris MOU	19
2.3	Conclusions	20
3	Vietnam Maritime Industry	25
3.1	Maritime Administration	25
3.1.1	Government Organisation	25
3.1.1.1	Overall Responsibility for Transport	25
3.1.1.2	Role of Vietnam National Maritime Bureau	29
3.1.1.3	Co-operation between Coastal Shipping and Inland Waterways	32
3.1.1.4	Role of Vietnam Register (VR)	36
3.1.2	Rules and Regulations	37
3.1.2.1	Maritime Code	37
3.1.2.2	International Conventions	38
3.1.2.3	Other Decrees	39
3.1.3	Inspection System	39
3.1.3.1	General	39
3.1.3.2	Law and Regulations	39
3.1.3.3	Ship Inspection	40
3.1.3.4	Training	42
3.2	Vietnamese Fleet	42
3.3	Conclusions	44
4	Port State Control Implementation: a Vietnamese Approach	46
4.1	General	46
4.2	Legislation	46
4.3	Administrative Structure	48
4.4	Training	51
4.4.1	Minimum Criteria for a PSCO	51
4.4.2	Training Program	52
4.5	Communication	53

4.6	Procedure of Inspection, Rectification and Detention	
	53	
4.7	Conclusions	57
5	Conclusions and Recommendations	58
5.1	Conclusions	58
5.2	Recommendations	59
	5.2.1 Legislation	60
	5.2.2 Maritime Administration	62
	5.2.3 Classification Society	63
	5.2.4 Operators	64
	Bibliography	66
	Appendices	
Appendix 1:	Laws and Regulations Concerned with Maritime Transport	68
Appendix 2:	Memorandum of Understanding on Port State Control in the Asia Pacific region	74
Appendix 3:	PSC Forms	84

LIST OF TABLES

Table 1.1: Statistics of PSC Inspections within Tokyo MOU	2
Table 2.1: Comparison of Agreements of Port State Control	22
Table 2.2: Status of Relevant Instruments	23
Table 2.3: Status of MARPOL 73/78	24
Table 3.1: Number of Ships Registered under VR	41
Table 3.2: Vietnamese Fleet Size Distribution by Types of Ships	42
Table 3.3: Age Distribution of Vietnamese Fleet	43

LIST OF FIGURES

Figure 3.1: Organisation Chart of Ministry of Transport	27
Figure 3.2: Maritime Administration Framework	28
Figure 3.3: Organisation Chart of VINAMARINE	30
Figure 3.4: Organisation Chart of Inland Waterway Bureau	33
Figure 3.5: Organisation Chart of Vietnam Register (VR)	35
Figure 4.1 Proposed Structure of VMSI	50
Figure 4.2: Flow Chart of Port State Control	54
Figure 4.3: PSC Recommended Procedure	56

GLOSSARY OF TERMS

ADB	Asian Development Bank
ATN	Aid to Navigation
COLREG	Convention on the International Regulations for Preventing Collisions at Sea
EEZ	Exclusive Economic Zone
ESCAP	Economic and Social Commission for Asia and the Pacific
EU	European Union
FOB	Flag of Convenient
GFRS	Global Foundation for Research and Scholarship
GT	Gross Tonnage
GMDSS	Global Maritime Distress and Safety system
IMO	International Maritime Organisation
ILO	International Labour Organisation
ILO No. 174	Merchant Shipping (Minimum Standards) Convention, 1976
ISM Code	International Safety Management
IWB	Vietnam Inland Waterway Bureau
LOADLINES	International Convention for the Safety of Life at Sea
MAPETRANSOCO	Maritime Petroleum Transport and Supply Company
MARPOL	International Convention for the Prevention of Pollution from Ships
MOT	Ministry of Transport
MOU	Memorandum of Understanding
MOP	Ministry of Finance
MPI	Ministry of Planning and Investment
PMU	Project Management Unit
PSC	Port State Control
PSCC	Port State Control Committee
PSCO	Port State Control Officer
RDITI	Research and Design Institute of Transport Industry
RITST	Research Institute of Transport Science and Technology

ROCRAM	Operative net of Regional collaboration among Maritime Authorities of South America, Mexico and Panama
SMA	Swedish Maritime administration
SOLAS	International Convention for the Safety of Life at Sea
STCW	International Convention on Standards for Training, Certification and Watchkeeping for Seafarers
TEDI	Transport Engineering Design Institute
TESI	Transport Economic Science Institute
TONNAGE	International Convention on Tonnage Measurement
TS	Territorial Sea
UNCLOS	United Nations convention on the Law of the Sea
VINALINES	Vietnam National Shipping Lines
VINAMARINE	Vietnam National Maritime Bureau
VINASHIN	Vietnam Shipbuilding Industry Corporation
VMS	Vietnam Maritime Safety Agency
VMSI	Vietnam Maritime Safety Inspectorate
VMU	Vietnam Maritime University
VNR	Vietnam National Railways
VR	Vietnam Register
VRA	Vietnam Road Administration Bureau
WATCO	Waterways Transport Company
WMU	World Maritime University

Chapter 1

INTRODUCTION

1.1 Necessity of Dissertation

Vietnam is a country which traditionally has a very closed relationship with maritime transport due to the fact that it has a long coastline--3620 km--embracing the eastern part of the Indochina peninsula. The maritime industry was appeared very early in its history and has experienced many up and down periods. In modern times the maritime industry always is an important sector in Vietnam. However there are still a great number of things which must be done to improve the maritime industry in Vietnam.

It is observed that international organisations including International Maritime Organisation (IMO) and International Labour Organisation (ILO) have been working very effectively and have introduced a considerable number of rules and regulations which predominantly cover all respects to ensure maritime safety and environmental protection. Many indications show the effects of these rules and regulations to the maritime industry. For instance, the number of annual maritime accidents has been reduced. However, accidents still keep occurring with the refrain of numbers of technical failures. Although the numbers of technical failures causing casualties has been reduced, it still remains at 20% of accidents. Therefore, it is necessary to set up a safeguard ensuring ships comply with conventions governing maritime safety and environmental protection. Port State control is an excellent mechanism for this purpose. Again, another issue arises, which is how to exercise port State

control properly to really maintain standards of shipping and unification of sanction to violations to conventions. This dissertation will partially propose the approach to solve this matter in Vietnam.

Table 1.1: Port State Control Inspections within Tokyo MOU
(Figures relevant to Vietnamese flag)

Year	Number of inspected ships	Number of ships with deficiency	Number of deficiencies	Number of ships detained	Detention percentage
1994*	19			2	10.5%
1995**	39	35	310	11	28.2%
1996***	51	43	637	28	54.9%
1997****	55	46	605	22	40 %

Source: (*) Cong Duc, 1998.

(**) Tokyo MOU, Annual Report 1995

(***) Tokyo MOU, Annual Report 1996

(****) Tokyo MOU, Annual Report 1997

Since 1982, when the European Memorandum of Understanding on Port State Control (Paris MOU) was signed, and especially since 1994, when the Asia-Pacific Memorandum of Understanding on Port State Control (Tokyo MOU) entered into force, Vietnam has faced a serious problem, which is that the number of Vietnamese ships detained by port States keeps increasing. According to statistics of Tokyo MOU, the percentage of Vietnamese ship detention was 10.5% in 1994. This figure went up to 54.9% in 1996, and in 1997 it was 40%. The detailed figures are show in the Table 1.1. In the context of Vietnam, almost all the ships engaged in international trade belong to state owned companies, which are entirely or partially controlled by the government in one way or another. Therefore, the Vietnamese maritime administration including Ministry of Transport (MOT), Vietnam National Maritime Bureau (VINAMARINE) and Vietnam Register (VR), who have regulatory functions and functions of advisement to the government about the development of the maritime industry, is responsible to address this matter. There

is a need to clearly define the responsibilities of each organisation to deal with port State control implementation. This is what this dissertation is written for.

In addition, fifteen previous dissertations of Vietnamese graduates from WMU have not dealt with port State control matters. Therefore, the author feels there is a need to help his colleagues and people who work in the maritime sector in his country to be aware of the importance of port State control procedures and understand the port State control mechanism, or at least draw more attention to matters of port State control implementation, which is more and more crucial to eliminating substandard ships, improving the effectiveness of the Vietnamese maritime industry.

1.2 Objectives

It is important to make clear to readers that this dissertation does not intend to build up a comprehensive plan to set up port State control systems in Vietnam. The dissertation focuses on three main objectives:

- (1) To provide basic knowledge and principles of the port State control mechanism in a transparent way;
- (2) To identify difficulties in the process of setting up port State control in Vietnam, and to propose a Vietnamese approach to implement the PSC procedure;
- (3) To draw some recommendations for improving the efficiency and effectiveness of the Vietnamese maritime administration and improving the port State control procedure implementation in Vietnam.

1.3 Scope

This Dissertation consists of five chapters that can be summarised as follows:

Chapter 1 contains the background information, the necessity of the dissertation, the objectives, the methodology and the scope of the study. It also describes some difficulties that the author has had to cope with while doing this dissertation.

Chapter 2 gives background knowledge on port State control in principle and explains how the port State control mechanism works and what the responsibilities of each party involved are. The chapter also gives some information about Tokyo MOU in comparison with Paris MOU.

Chapter 3 presents the current situation of the Vietnamese maritime industry. Furthermore, it analyses some weaknesses in the maritime administration, legislation, and operation.

Chapter 4 presents an approach for Vietnam to implement port State control procedures, taking into account the facts and analysis in Chapter 3. The chapter suggests a practical procedure for port State control and gives an administrative structure of Vietnam Maritime Safety Inspectorate (VMSI) to conduct port State control inspections.

Chapter 5 gives some conclusions and recommendations to improve the effectiveness of the maritime administration and port State control procedure implementation.

1.4 Methodology

This study is entirely based on the following:

- reference materials available at the World Maritime University library;
- studies on the profiles of other countries' port State control procedures undertaken and delivered by various resourceful persons;
- reference materials collected from the MOT, VINAMARINE, VR;
- field studies to a number of maritime administrations, including field studies to Japan, Germany and the Nordic countries;
- the personal knowledge of the author gained during his working period and studies at WMU

The methods used to carry out the study include the following:

- describing the existing situation of the Vietnamese maritime administration;
- analysing problems and causes;
- discussing with and interviewing experts on port State control and persons in charge from the Vietnamese maritime administration;
- generating personal arguments.

1.5 Difficulties

The dissertation has been prepared during the two years studies at WMU. It, therefore, has been a great difficulty to access updated information in Vietnam. In addition, the author himself is not an administrator or a civil servant. Hence, his opinion is the view of a customer of the Administration and he has difficulty to interview people at high rank of organisations, such as Chairman of the VINAMARINE, or Director General of the VR. Furthermore, this dissertation is written in English, which is not the mother language or working language of the author. Therefore, there are possibly some points that are not properly expressed or may be misleading.

After finish this dissertation as partial fulfilment of graduation requirement, the author will still be seeking for and welcoming comments and critiques from professors, his colleges and people who are interested in the subject to improve this work.

Chapter 2 BACKGROUND TO PORT STATE CONTROL

2.1 General

2.1.1 What is Port State Control?

There are numbers of definitions of port State control in many maritime books, theses, and periodical issues. Among them, the definition given by Mr John Hare in his article, which first appeared in Volume 26, Issue 3 of the Georgia Journal of International and Comparative Law--Special Admiralty Issue, 1997, is one that best describes the Port State Control concept:

"Port State Control" as a concept, involves the powers and concomitant obligations vested in, exercised by, and imposed upon a national maritime by international convention or domestic statute or both, to board, inspect and where appropriate detain, a merchant ship flying a flag foreign to that state in order to ensure compliance by that ship with all applicable international safety at sea and environmental protection instruments and with relevant domestic legislative maritime safety requirements.

(John Hare, 1997)

Before going to further discussion, it is also important to know what 'port State' means. Like 'flag State' and 'coastal State', 'port State' is contextual definition *vis à* *vis* ship:

- 'flag State' is the state whose nationality is held by a ship

- ‘coastal State’ is the state within whose maritime zone a foreign ship is for the time being.
- ‘port State’ is the state in whose port or off-shore terminal a foreign ship is for the time being.

2.1.2 Why Port State Control needs to be Introduced and Expanded?

Primarily, only the flag State has exclusive jurisdiction over ships holding its nationality. However, shipping is a very international industry. A ship flying the flag of one country trades in many other countries’ waters. This characteristic makes it very difficult for flag State to exercise its control fully and effectively over its ships. In addition, the introduction of “Flag of Convenience” (FOC) leads many states to turn a blind eye to the condition of the vessels. In practise, no maritime administration has sufficient resources to maintain control over its ships, especially ships engaged in international voyages. Consequently, the technical condition of ships may go out of the hand of flag States. This ultimately endangers the safety of the ships themselves and the environment of the waters and the ports or the off-shore terminals they call at. To compensate, many flag States use the international network of qualified surveyors maintained by classification societies. With the assistance of classification societies, flag States are more confident, but again, many casualty reports show the causes of these casualties are deficiencies in technical condition of the ships or the lacks of skills or qualifications of the masters or crew.

Maritime casualties very often accompany with impacts on marine environment of coastal States or port States. The United Nations Convention on the Law of the Sea (UNCLOS), on one hand, confers the right of *‘innocent passage’* to all foreign ships. On the other hand, it gives coastal States the right to exercise the jurisdiction in respects of environmental protection over ships in its Exclusive Economic Zone (EEZ) or territorial sea (TS). Port States have the right to set up any requirement, which does not go beyond the international acceptances, over ships that wish to enter its internal water, including its ports and terminals.

The IMO Resolution A.466 (XII)--Procedure for the Control of Ships--and resolution A.787 (19)--Procedure of Port State Control--formed the basis of port State control. The idea of port State control is to maintain ship control in respect of ship safety and environmental protection and to unify sanctions against violations of international conventions. At the same time, port State control is a follow-up activity of flag State control. Furthermore, the memoranda of understanding (MOUs) provide guidelines for harmonisation of port State control inspections, promotion of surveyor training exchange and strengthening of communication between maritime authorities within regions and world-wide.

Mr William O' Neil the current Secretary General of IMO, who deeply understood the need of introduction and expansion of PSC implementation, had emphasised in the World Maritime day 1996

Shipping is an international industry which is proud of its tradition of freedom of the seas, but that does not mean that ships can sail wherever they like regardless of their condition. The maritime world has the right to expect that ships of all nations meet the levels of safety and environmental protection which have been internationally agreed upon. It is up to shipowners to make sure that their ships are safe, properly manned and do not pollute the seas. And it is the duty of governments to make sure that ships which fly their flag comply with the standards laid down in the IMO treaties which they have ratified. If they fail to do so, then IMO -- which has the stewardship of these standards -- has not only the right but also the obligation to take further action.

(William O' Neil, 1996)

2.1.3 Port State Enforcement Regime

Historically, under the "floating island" doctrine, only the flag State had exclusive jurisdiction over ships holding its nationality. There are now instances of "dual" or "concurrent jurisdiction" with the arising of coastal and port State jurisdictions (Mukherjee, 1998). Port State jurisdiction was first introduced for detailed international consideration at the 1973 IMO Conference on Marine Pollution (Kasoulides, 1993). Formulation of the port State authority of a coastal State, which

was laid down in the United Nations Convention on the Law of the Sea (UNCLOS), is now included in a number of maritime conventions, such as the 1966 Load Lines Convention (LL 66), the MARPOL 73/78, the SOLAS 74/78, the ILO Convention No. 147, the STCW 95, the Dumping Conventions, the 1969 Convention on Civil Liability and the 1986 United Nations Convention on Condition for Registration of Ships.

In those conventions, the port State has enforcement authority over the ship as it enters the port in question, regardless whose flag it is flying, in respect of control of ships and their equipment (SOLAS 74/78, Load Lines, MARPOL 73/78), control of discharges at sea (OILPOL, MARPOL, Dumping Conventions), control of crew competence and working conditions (ILO No. 147, STCW) and other requirements. On the other hand, port State jurisdiction meant that:

a state may exercise enforcement jurisdiction over foreign ships in its ports in respect of offences against international rules and standards even if committed in sea areas beyond its coastal jurisdiction . . . even if the violations were committed on the high seas (or foreign waters) and they did not in any way affect the port State the latter would be entitled to take enforcement action against the vessel concerned

(Kasoulides, 1993,111).

The main characteristics of the port State enforcement regime can be summarised as follows:

- (1) Voluntaryness: This is an essential element of the new regime. A port State can not compel a vessel on the high seas, or even in its own territorial waters or EEZ, to proceed to one of its ports and face proceeding.
- (2) Port and offshore terminals: The exercise of this power is restricted to these areas and does not include the functional internal waters area.
- (3) Investigation and adjudicative powers: The jurisdiction is engaged solely by reason of the voluntary presence of a delinquent or suspect vessel in its ports;

the enforcement prerogative, therefore, is primarily investigative and only secondarily adjudicative.

- (4) Discharge and pollution: The enforcement power is restricted to discharges from ships. These include accidental and intentional discharges of oil, noxious and hazardous substances in bulk or packaged form, sewage and garbage, i.e. discharges such as re-ballasting, tank cleaning activities and leaking from engines.
- (5) International waters: This procedure is to be followed only in the case of an incident with no “territorial link” to the port state.
- (6) Applicable international standards: The port State may only enforce standards that are either part of customary international law or laid down in maritime conventions on the related issue, e.g. MARPOL 73/78 discharge standards. This provision excludes resolutions, guidelines and codes that are not already incorporated in customary international law.
- (7) Competent international organisations: This is generally accepted to be the IMO;
- (8) A right to enforce: The port State has only a discretionary power to enforce and may decline to do so.
- (9) Discharge in foreign waters: No investigation may be undertaken except if the port State is so requested by another interested UNCLOS party. Even then, the port State must comply as far as practicable with a request. The coastal State could also ask for the suspension of such proceedings.
- (10) The role of the flag State: It may request the investigation of discharge violations by its vessels on the high seas or foreign waters. It may also decide to pursue legal proceedings in its national courts. The port State must interrupt its own proceedings if a flag State decides to do so (Art. 228 UNCLOS).
- (11) Penalties: Although the UNCLOS specifically refers to monetary penalties, the article 230(2) further suggests, by implication, that imprisonment can be ordered as sanction in the case of wilful and serious pollution of the territorial sea (Kasoulides, 1993).

2.1.4 Port State Control Framework

Ensuring and improving safety on board ships and environmental protection require a comprehensive framework. Several parties are involved in these matters, namely national administrations, classification societies, owners and crew. Each party has different kinds of responsibility.

- (1) National administrations are responsible for taking the necessary measures to ensure ships flying their states' flag comply with provisions of the relevant conventions and to ensure the availability of reception and treatment facilities. Surveying and issuing certificates under international conventions are also responsibilities of national administrations. The national administrations also have to control foreign ships entering its port in respect of safety and environmental protection. In other words, national administrations must fulfil the obligations and responsibilities of flag states over ships flying their flags, and the obligations and responsibilities of port states over ships calling at their ports (to be further discussed in 2.1.4.1 and 2.1.4.2)

- (2) Classification societies are the recognised organisations, which are authorised by most of the national administrations to inspect ship designs, to carry out class surveys during and after construction of ships and to issue certificates under the international conventions. Classification societies act on behalf of national administrations.

- (3) The owners are responsible for
 - a) ensuring their ships and crew comply with requirements of international conventions,
 - b) providing sufficient financial support for the activities aiming at improving safety on board their ships,
 - c) providing proper instructions to their ships in the form of manuals,
 - d) maintenance of ships,

- e) operating proper safety management systems as required in the ISM Code within their organisation, and
 - f) collecting and presenting proofs and evidences in the case of an unduly detained ship.
- (4) The crew on board ships must be qualified, hold certificates of competence required under international conventions and by national administration (if any), and have enough skills and knowledge to fulfil the tasks that they have been assigned. They should always be looking for improvement of their skills through training and drilling.

2.1.4.1 Responsibilities and Obligations of Flag State

Regarding flag State matters, the national administration is obliged and responsible

- (1) to enforce the international maritime standards which have been set in international conventions over all ships flying its flag;
- (2) to communicate with IMO about the list of non-governmental agencies which are authorised to act on its behalf, the text of law and regulations within the scope of conventions, and sufficient number of specimens of its certificates issued under international conventions;
- (3) to carry out ship surveys including initial, annual, intermediate and renewal surveys, and to issue certificates under international conventions;
- (4) to provide proper training for seafarers and issue certificates of competence;
- (5) to undertake the necessary arrangements for receiving reports from port states relating to ships flying its flag, and immediately replying to port states and to states whose interests are affected;
- (6) to instruct ships flying its flag to report incidents to its own national administration and to other state(s) concerned;
- (7) to carry out casualty investigation of ships flying its flag.

2.1.4.2 Responsibilities and Obligations of Port State

The responsibilities and obligations of the national administration when acting as a port state are

- (1) to verify the certificates on board ships are valid and sufficient to the provisions of the international conventions, which are currently in force in the port State;
- (2) to accept all the valid certificates issued by flag State unless there are clear grounds to identify that the ship is a substandard ship (to be discussed in 2.1.4.3);
- (3) to take a further step to ensure the ship does not sail until it can proceed to sea without presenting a danger to the ship or persons on board, or without presenting an unreasonable threat of harm to the marine environment;
- (4) to report without delay to flag State about any action that has been taken related to ships flying its flag, and notice to IMO, to states whose interests are affected, and also to ILO in case of violation to ILO 147;
- (5) to ensure that no more favourable treatment is given to ships flying the flag of a non-party to an international convention;
- (6) to provide experienced and qualified port State control officers (PSCO) and all necessary arrangements to carry out port State control inspections; and
- (7) not to unduly detain or delay ships in its port otherwise port State will be liable for this.

2.1.4.3 Identification of Substandard Ships

According to Resolution A.787(19) the basis for detaining a ship is that the ship is a substandard ship. A port state control officer can judge a ship as a substandard ship when he goes on board the ship and finds one or more of the items listed below:

- (1) the absence of principal equipment or arrangements required by the conventions

- (2) non-compliance of equipment or arrangements with relevant specifications of the convention
- (3) substantial deterioration of the ship or its equipment because of, for example, poor maintenance
- (4) insufficiency of operational proficiency, or unfamiliarity of essential operational procedures by the crew
- (5) insufficiency of manning or insufficiency of certification of seafarers
- (6) any evident factor making the ship unseaworthy, or putting risk to the safety of the ship or lives of persons on board, or presenting a threat to the marine environment
- (7) the lack of valid certificates required by international conventions

2.1.4.4 No More Favourable Treatment

The “No More Favourable Treatment” clause affects ships flying flags of non-parties and ships that are below convention size. The “No More Favourable Treatment” clause requires that

- (1) the flag State administration of a non-party must carry out surveys on and issue certificates to ships flying its flag at the equivalent level as ship surveys and certificates under international conventions;
- (2) all States must carry out measures to ensure ship safety and environmental protection over their ships below convention size;
- (3) a port State, when carrying out port State control inspections on ships calling at its ports or offshore terminals, must apply the port State control procedures set in the IMO resolution A.787(19), regardless of whether ships are entitled to flying the flag of a non-party or a party to international conventions. Furthermore, a port State must carry out equivalent inspections onboard ships below convention size.

2.1.5 Regional PSC Agreements

A Memorandum of Understanding (MOU) is an instrument of a less formal kind than a treaty and in the maritime context usually details operational arrangements or requirements dealing with technical matters. It relates to conduct or intention and is not legally binding, but it has a political and/or a moral force (Kasoulides, 1993). Practical experience shows that implementation of the PSC procedure is best done on a regional basis. There are some advantages to the concept of regional co-operation on PSC. These can be summarised as follows:

- (1) Maximum commitment is obtained from participating countries that share common safety and environmental interests.
- (2) The use of information available regionally is done more effectively.
- (3) Ships remain under surveillance as long as they operate in the region, thereby reducing the possibilities for sub-standard operations.
- (4) Operational costs are shared by all participating port States.
- (5) A harmonised approach to procedures lowers the burden on ship's staff and permits effective deployment of available resources of participating States.
- (6) Harmonised procedures prevent distortion of competition between regional ports.

The first regional PSC agreement, covering Europe and the North Atlantic, was signed in 1982 and is known as the Paris Memorandum of Understanding (Paris MOU). The Latin American Agreement (Acuerdo de Viña del Mar) was signed in 1992; the Tokyo Memorandum of Understanding (Tokyo MOU), covering Asia and the Pacific, in 1993; the Caribbean Memorandum of Understanding (Caribbean MOU) in 1996; the Mediterranean Memorandum of Understanding (Mediterranean MOU) in 1997; and the Indian Ocean Memorandum of Understanding (Indian Ocean MOU) in 1998.

On 22 January 1999 eighteen West and Central African States agreed on a draft of Memorandum of Understanding (MOU) on port State control (PSC). This will result in the seventh MOU--West and Central African MOU--to be adopted in October this year (1999) in Nigeria.

Sooner or later, it is expected that the world will be covered by regional agreements, perhaps leading to the creation of a global system which will make it virtually impossible for sub-standard ships to escape detection.

2.2 Tokyo MOU

The Memorandum was adopted in Tokyo on 1 December 1993 by the following maritime Authorities in the Asia-Pacific region: Australia, Canada, China, Fiji, Hong Kong, Indonesia, Japan, Republic of Korea, Malaysia, New Zealand, Papua New Guinea, the Philippines, the Russian Federation, Singapore, Solomon, Thailand, Vanuatu and Vietnam. The Memorandum came into effect on 1 April 1994.

The main objective of the Memorandum is to establish an effective port State control regime in the Asia-Pacific region, through co-operation and harmonisation, to eliminate substandard ships so as to promote maritime safety, to protect the marine environment and to safeguard working and living conditions on board.

A Port State Control Committee was established to monitor and control the implementation and on-going operation of the Memorandum. The Committee consists of representatives of the maritime Authorities, representatives from the International Maritime Organisation (IMO), the International Labour Organisation (ILO), the Economic and Social Commission for Asia and the Pacific (ESCAP), the Paris MOU and the United States. A permanent secretariat of the Memorandum was formed in Tokyo, Japan.

For the purpose of the Memorandum, the following are provided as relevant instruments:

- (1) the International Convention on Load Lines 1966
- (2) the International Convention for the Safety of Life at Sea, 1974 as amended
- (3) the Protocol of 1978 relating to the International Convention for the Safety of Life at Sea, 1974

- (4) the International Convention for the Prevention of Pollution from Ships 1973, as modified by the Protocol of 1978 relating thereto
- (5) the International Convention on Standards for Training, Certification and Watchkeeping for Seafarers, 1978, as amended
- (6) the Convention on the International Regulations for Preventing Collisions at Sea, 1972
- (7) the International Convention on Tonnage Measurement of Ships, 1969
- (8) the Merchant Shipping (Minimum Standards) Convention, 1976 (ILO Convention No. 147)

2.2.1 Development of the Tokyo MOU

In the 80s and beginning of the 90s, in the Asia Pacific regions, port State control was conducted in several countries and territory like the Philippines, Japan, Australia, Canada, China and Hong Kong, but there was no regional co-operation between the maritime administrations of these countries. In 1982, the Paris Memorandum of Understanding on port State control was signed and implemented, attempting to reduce and eliminate operation of substandard ships in European waters and to ensure the safety of life at sea and the prevention of pollution. In 1991, the 17th Assembly of the International Maritime Organisation adopted resolution A.682, which, among other things,

- (1) recognised the contribution by port State control to maritime safety and pollution prevention made through regional co-operation under the European MOU,
- (2) urged members to form regional co-operation on port State control in other regions to contribute to the elimination of substandard ships and
- (3) invited governments to consider regional arrangements on port State control.

Having considered the European experience and in response to IMO resolution A.682, countries in the Asia Pacific region realised the need of having a port State control agreement in the region to harmonise their inspection procedures and improve port State control for those who already had it in place and encourage the others to implement port State control.

As a result, in December 1993, the Asia Pacific Memorandum of Understanding on port State control, also called the Tokyo MOU, was signed by eighteen participating maritime authorities in the region. It is agreed to establish the Secretariat of the Tokyo MOU which will locate in Tokyo. The Memorandum came into effect on 1 April 1994.

2.2.1.1 Why Vietnam not a Member of Tokyo MOU PSCC from Beginning?

In 1993 the Vietnamese Government representatives signed the Tokyo MOU, but Vietnam still had an observer status to the Tokyo MOU until 1999. The reasons for this may rest on the lack of attention of the Vietnamese government to the maritime sector, the lack of consciousness of the impact of the MOU and the inefficient bureaucratic administration with the heavy burden of documentation work. One of the most active people who is anxious to convince the Vietnamese government to join the Tokyo MOU is Mr Nguyen Cong Duc – the current Director of the Hai Phong Port Authority. He has made the proposal to VINAMARINE and has also been giving a number of speeches about this matter.

In Chapters 3, shortcomings in the organisation and framework of the Vietnamese maritime administration will be further discussed.

2.2.2 Tokyo MOU in Comparison with Paris MOU

Before the Tokyo MOU comes into existence, there were two agreements on port State control in place, namely the Paris MOU (signed on 2 March 1978) and the Latin America Agreement (signed on 5 November 1992). Generally speaking, the Tokyo MOU is similar to the Paris MOU in many aspects. As shown on the Table 2.1 (at the end of this chapter), they are all comprised by a number of countries in their regions. The target inspection rate of the Paris MOU is 25% annual inspections per country within 3 years from entry into force, the number for the Tokyo MOU is 25% annual inspections per country by the year 2000. However, the Tokyo MOU has several features different from that of the Paris MOU.

The Paris MOU members comprise European countries whose inspection capabilities and infrastructures are already in place for carrying out effective port State control. In addition, most of the European countries, particularly those participating in Paris MOU, are in the same level of economic development, which is categorised as industrialised. The maritime administrations of these countries also have high efficiency and effectiveness. Besides that, they possess large fleets of merchant ships with well-trained personnel. Finally, for countries who are members of the EU, the Paris MOU is made mandatory under a European Commission Directive (Ulstrup, 1999).

In contrast, the Tokyo MOU participants are in very different levels of economic development and include developed countries (Japan, Canada), developing countries (Vietnam, China) and low level of development countries (Fiji, Solomon Islands). Therefore, the level of resources availability is not equal for all these countries. The highly developed countries own the very modern fleets, which can meet all the requirements of international conventions, while the fleets of the other countries have rather high average ages. This is almost impossible for those fleets, or they have to try very hard, to reach the technical standards stipulated by international conventions.

Another feature comes from maritime administration. The capabilities of maritime administrations vary from country to country. Some of them have very good inspection systems and have already port State control in place, while many other do not. For instance, at the time of Tokyo MOU signature in 1993, in some of these countries, port State control had not been set up, even in the preparatory stages like Vietnam and Solomon Islands.

Furthermore, the status of ratification of international conventions among the Tokyo MOU participants is not at the same level (see Table 2.2 and 2.3). Only a few countries such as Japan and South Korea have ratified all the seven relevant instruments, while many others have ratified four, five or six instruments. The Solomon Islands have ratified only two instruments--STCW 78 and COLREG 72.

This situation, obviously, leads the disunification of implementation of international conventions.

The variation in stages of development, capabilities of the maritime administration and status of ratification put more difficulties toward the introduction of the Tokyo MOU in the region. On the other hand, it also gives more pressure to the harmonisation of implementing port State control procedures through unification of education and training for surveyors and the development of the regional manual for inspectors.

2.3 Conclusion

It is universally acknowledged that once a ship voluntarily enters a port it becomes fully subject to the laws and regulations prescribed by the officials of that and that all types of vessels are obliged to comply with the coastal regulations about proper procedures to be employed and permissible activities within internal waters.

Six memoranda of understanding on port State control have been signed in the world, aiming to help the flag State continuously control ships flying its flag by harmonising inspection procedures and unifying sanction against violations to the international conventions. Furthermore, they encourage states to ratify and implement international conventions. The memoranda also promote regional co-operation and training exchanges.

Combating with resistance from external and internal sources, Vietnam has realised the benefits of implementing port State control procedures, and of having close regional co-operation. Early in 1999, Vietnam became a member of the Tokyo PSCC and started the process of setting up a port State control system in Vietnam.

Table 2.1: Comparison of Agreements of Port State Control

	Paris MOU	Latin America agreement	Asia Pacific MOU
Participating countries and associate members	Belgium, Denmark, Finland, France, Germany, Greece, Iceland, Italy, Netherlands, Spain, Norway, Poland, Portugal, Sweden, UK	Argentina, Brazil, Chilli, Colombia, Ecuador, Mexico, Peru, Venezuela, Panama, Uruguay	Australia, Canada, China, Indonesia, Japan, Malaysia, New Zealand, Fiji, Papua new Guinea, Philippine, Russia, Vanuatu, Hong Kong, Thailand, Vietnam, Solomon Island
Co-operation country	Canada, Croatia, Japan, Russia, USA	None	None
Target inspection rate	25% annual inspection rate per country within 3 year from entry into force	15% annual inspection rate per country within 3 year from entry into force	25% annual inspection rate per country by the year 2000
Relevant instrument	LL 1966 LL Prot 1988 SOLAS 1974 SOLAS Prot 78, 88 MARPOL 73/78 STCW 78 COLREG 72 TONNAGE 69 ILO No. 147	LL 1966 SOLAS 1974 SOLAS Prot 78 MARPOL 73/78 STCW 78 COLREG 72	LL 1966 SOLAS 1974 SOLAS Prot 78 MARPOL 73/78 STCW 78 COLREG 72 TONNAGE 69* ILO No. 147
Special attention	Passenger ships, Ro-ro ships, Bulk carriers, Ships may present a special hazard, Ships which have had several recent deficiencies, Ships flying the flag of a state appearing in 3 years rolling average table of delays and detention	Passenger ships, Ro-ro ships, Bulk carriers, Ships may present a special hazard, Ships which have had several recent deficiencies	Passenger ships, Ro-ro ships, Bulk carriers, Ships may present a special hazard, Ships which have had several recent deficiencies, Ships flying the flag of a state appearing in 3 years rolling average table of delays and detention, Ships which haven't been inspected by an Authority within 6 months
Amendments	Will take effect 60 days after acceptance	Will take effect 60 days after acceptance	Will take effect 60 days after acceptance
Information Centre	Saint Mallow, France	Buenos Aires, Argentina	Canada
Committee	a representative of each of the authorities and of the commission of the EU	a representative of each of the authorities	a representative of each of the authorities
Observers secretariat	IMO, ILO	IMO, ROCRAM	IMO, ILO, ESCAP
signed	2 March 1978	5 November 1992	2 December 1993
Official language	English, French	Spanish, Portuguese	English

Source: IMO news February 1994

(*) updated by 1998 amendment to Asia Pacific MOU text

Table 2.2: Status of Relevant Instruments
(As at December 31 1997)

Authority	LOAD LINE 66	SOLAS 74	SOLAS PROT 78	MARPO L 73/78	STCW 78	COLREG 72	ILO 147
Australia	29/07/68	17/08/83	17/08/83	14/10/87	07/11/83	29/02/80	-
Canada	14/01/70	08/05/78	-	16/11/92	06/11/87	07/03/75	25/05/95
China	05/10/73	07/01/80	17/12/82	01/07/83	08/06/81	07/01/80	-
Fiji	29/11/72	04/03/83	-	-	27/03/91	04/03/83	-
Hong Kong China	16/08/72	25/05/80	25/11/81	11/04/85	03/11/84	15/07/77	28/11/80
Indonesia	17/01/77	17/02/81	23/08/88	21/10/86	27/01/87	13/11/79	-
Japan	15/05/68	15/05/80	15/05/80	09/06/83	27/05/82	21/06/77	31/05/83
Republic of Korea	10/07/69	31/12/80	02/12/82	23/07/84	04/04/85	29/07/77	-
Malaysia	12/01/71	19/10/83	19/10/83	31/01/97	31/01/92	23/12/80	-
New Zealand	05/02/70	23/02/90	23/02/90	-	30/07/86	26/11/76	-
Papua New Guinea	18/05/76	12/11/80	-	25/10/93	28/10/91	18/05/78	-
Philippines	04/03/69	15/12/81	-	-	22/02/84	-	-
Russian Federation	04/07/66	09/01/80	12/05/81	03/11/83	09/10/79	09/11/73	07/05/91
Singapore	21/09/71	16/03/81	01/06/84	01/11/90	01/05/88	29/04/77	-
Thailand	30/12/92	18/12/84	-	-	-	06/08/79	-
Vanuatu	28/07/82	28/07/82	28/07/82	13/04/89	22/04/91	28/07/82	-
Solomon Island	-	-	-	-	01/06/94	07/07/78	-
Vietnam	18/12/90	18/12/90	12/10/92	29/05/91	18/12/90	18/12/90	-
Date of entry into force	21/07/68	25/05/80	01/05/81	02/10/83	28/04/84	15/07/77	28/11/81

Source: Tokyo MOU, Annual Report 1997

Table 2.3: Status of MARPOL 73/78
(As at December 31 1997)

Authority	Annexes I & II	Annex III	Annex IV	Annex V
Australia	14/10/87	10/10/94	-	14/08/90
Canada	16/11/92	-	-	-
China	01/07/83	13/09/94	-	21/11/88
Fiji	-	-	-	-
Hong Kong China	11/04/85	07/03/95	-	27/03/96
Indonesia	21/10/86	-	-	-
Japan	09/06/83	09/06/83	09/06/83	09/06/83
Republic of Korea	23/07/84	28/02/96	-	28/02/96
Malaysia	31/01/97	-	-	31/01/97
New Zealand	-	-	-	-
Papua New Guinea	25/10/93	25/10/93	25/10/93	25/10/93
Philippines	-	-	-	-
Russian Federation	03/11/83	14/08/87	14/08/87	14/08/87
Singapore	01/11/90	02/03/94	-	-
Thailand	-	-	-	-
Vanuatu	13/04/89	22/04/91	-	22/04/91
Solomon Islands	-	-	-	-
Vietnam	29/05/91	-	-	-
Date of entry into force	02/10/83	01/07/92	-	31/12/88

Source: Tokyo MOU, Annual Report 1997

Chapter 3

VIETNAM MARITIME INDUSTRY

This chapter attempts to present the current situation incorporate with some analyses of the Vietnamese maritime industry, which includes two main parts--the maritime administration and Vietnamese fleet. For the purpose of the dissertation, the chapter more concentrates to describe and analyse the maritime administration from the maritime administration framework, to main organisations like VINAMARINE and VR. A brief introduction of maritime rules and regulations applicable in Vietnam are also included in this chapter

3.1 Maritime Administration

3.1.1 Government Organisation

3.1.1.1 Overall Responsibility for Transport

Overall responsibility for administering coastal shipping rests with the Ministry of Transport (MOT) which presently supervises all forms of transport through agencies responsible for specific modes, including the Vietnam National Maritime Bureau (VINAMARINE) for coastal and ocean-going shipping and the Inland Waterway Bureau (IWB) for inland waterway. As shown in Figure 3.1, the MOT has several departments to handle matters such as planning and investment, legislation, and setting maintaining

technical standards. In addition, it has specialist support units responsible for particular functions such as Vietnam Register (VR) which classifies and issues technical certificates of sea-going vessels.

Some transport construction organisations report to the MOT. In addition, several project implementation units (PMUs) have been established in recent years to handle the administration of major World Bank and ADB funded highway projects.

A number of institutes are responsible to the MOT. For example, the Transport Economic Science Institute (TESI) conducts traffic forecasts and other studies, the Transport Engineering Design Institute (TEDI) and the Research Institute of Transport Science and Technology (RITST) both have expertise in many technical aspects of maritime transport, and Vietnam Maritime University (VMU) conducts training of seafarers.

The interests of the MOT at regional level are served through Provincial or District Transport Authorities. These are under the People's Committees and are responsible for implementing the national annual plan as it affects their particular province. They refer to the MOT both over matters concerning legal transport standards and over administration of public sector transport organisations delegated to them by the MOT (including many inland waterway and coastal shipping transport companies and provincial ports). With regard to many day-to-day matters concerning operations and maintenance of transport infrastructure, they report to the People's Committees in the province. These committees are not local authorities in the traditional sense, with tax raising powers and rights to own property. They are financially controlled by the central government.

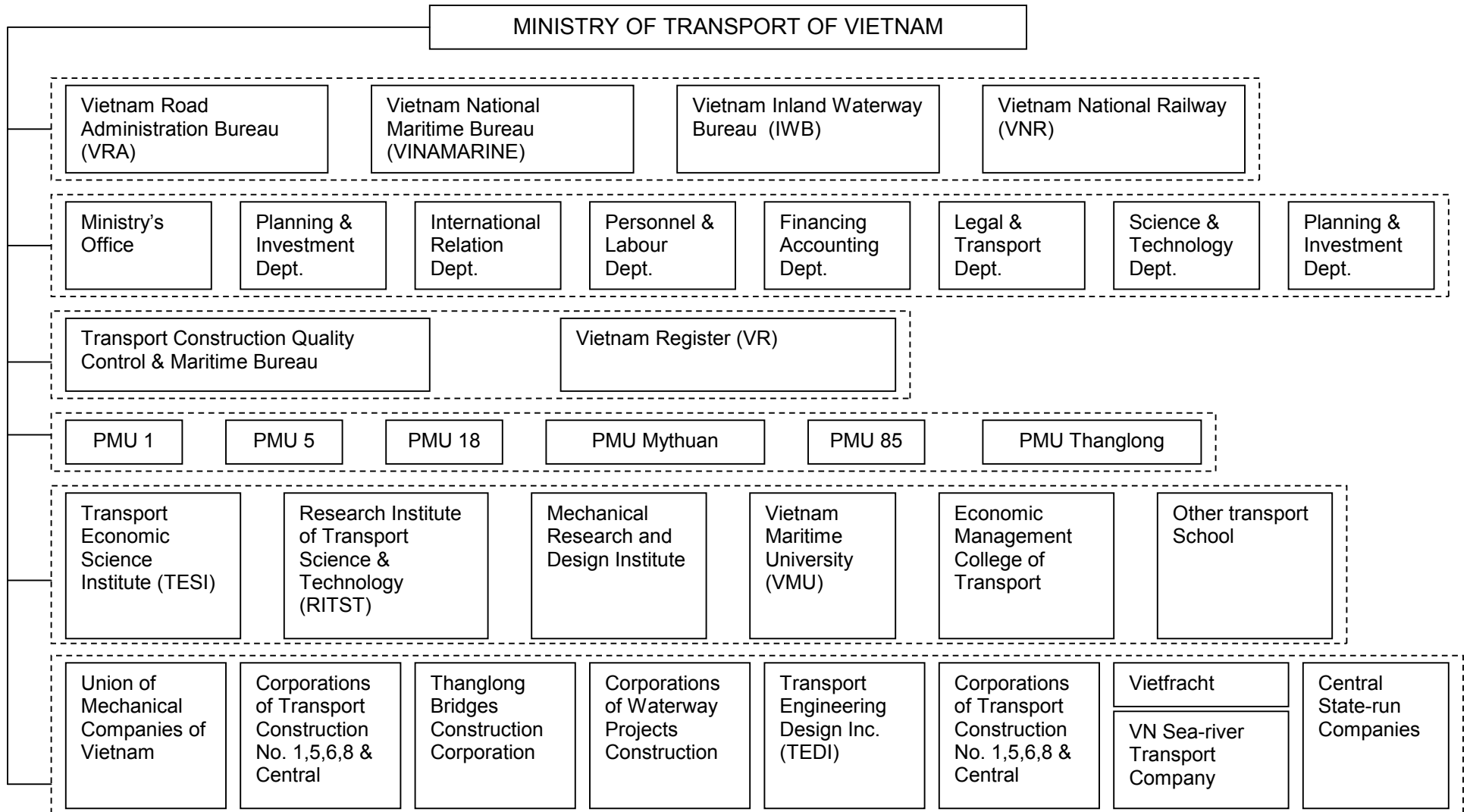

Figure 3.1: Organisation Chart of Ministry of Transport

(Source: Ministry of Transport)

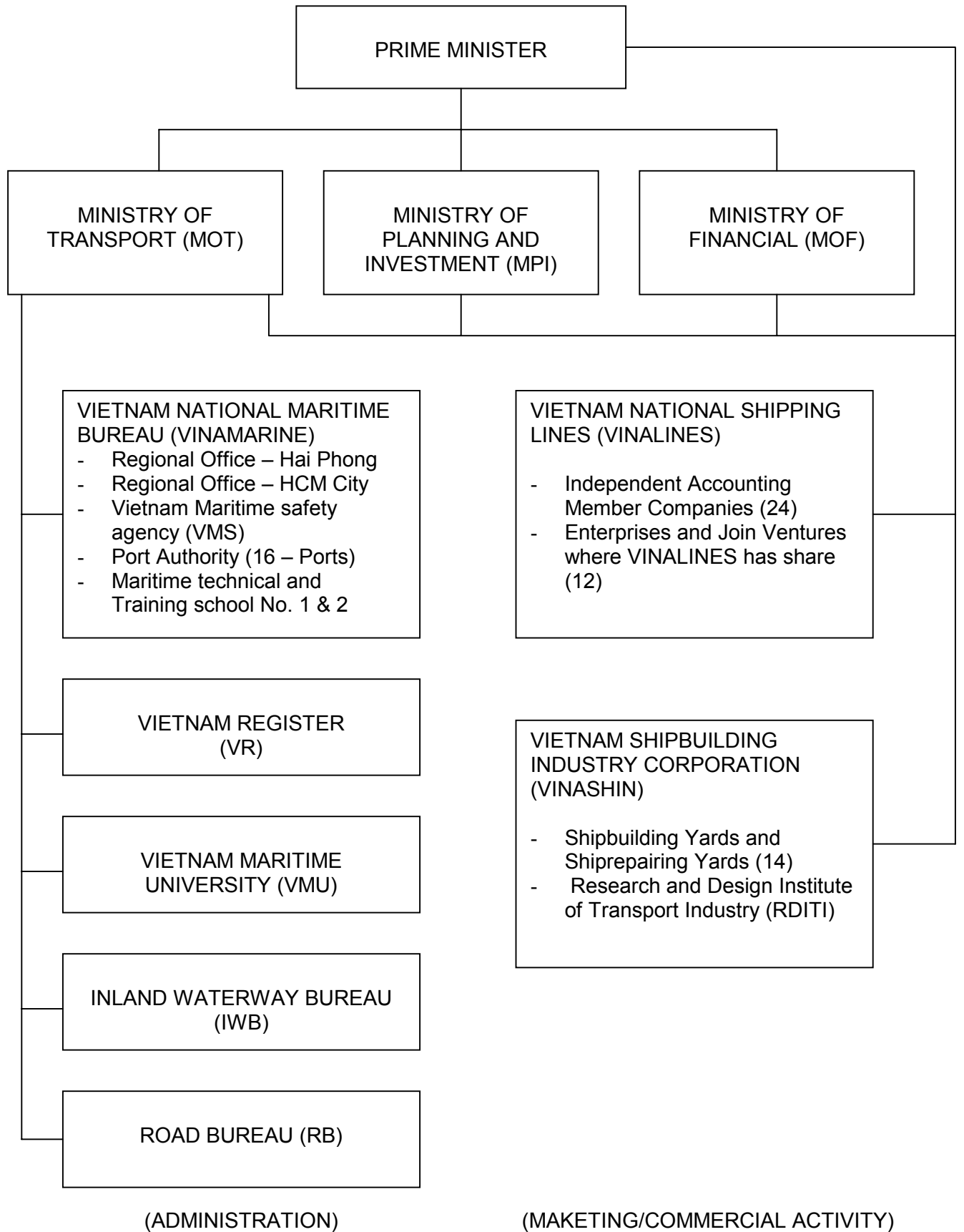

Figure 3.2: Maritime Administration Framework

(Source: VINAMARINE, 1998)

Other ministries have responsibilities in transport, especially the Ministry of Planning and Investment (MPI) and the Ministry of Finance (MOF). The former has responsibility for most major capital investments by government in transport (including infrastructure such as ports and waterways) whereas the latter controls other aspects of expenditure. The Prime Minister's Office itself administers certain transport operational units such as the Vietnam National Shipping Lines (VINALINES) which is the general corporation administering state operators in the maritime sector, and the Vietnam Shipbuilding Industry Corporation (VINASHIN), see Figure 3.2. Other operational units in shipping are administered by VINAMARINE, by the Ministry of Industry (dedicated sea and river coal ports), by the Ministry of construction (river ports for cement factories), by the ministry of Trade (all oil berths and most oil tanker operations), by the Ministry of Agriculture and Rural Development (river ports) and by the Ministry of Defence (military ports and shipping).

3.1.1.2 Role of Vietnam National Maritime Bureau (VINAMARINE)

Until 1 January 1996, VINAMARINE was responsible not only for regulatory functions in the maritime sector but also for operational management functions of many ships, ports and shipyards. It had a staff of 30,000 working at its head office in Hanoi (it had been in Hai Phong until 1996) and at subsidiary companies and enterprises. The VINAMARINE acted as co-ordinator of maritime enterprises and assumed governmental responsibility for managing Vietnamese shipping activities including seaports, merchant fleets, shipyards, ship servicing companies and registration of ships. Now almost all these commercial functions have been transferred to the VINALINES (ship and port management) or VINASHIN (a similar organisation in shipyard management), leaving VINALINES mainly to concentrate on its important regulatory function. This is performed through its head office, three branch offices, eighteen port authorities and other agencies, such as the Vietnam Maritime Safety Agency (VMS), directly under its control.

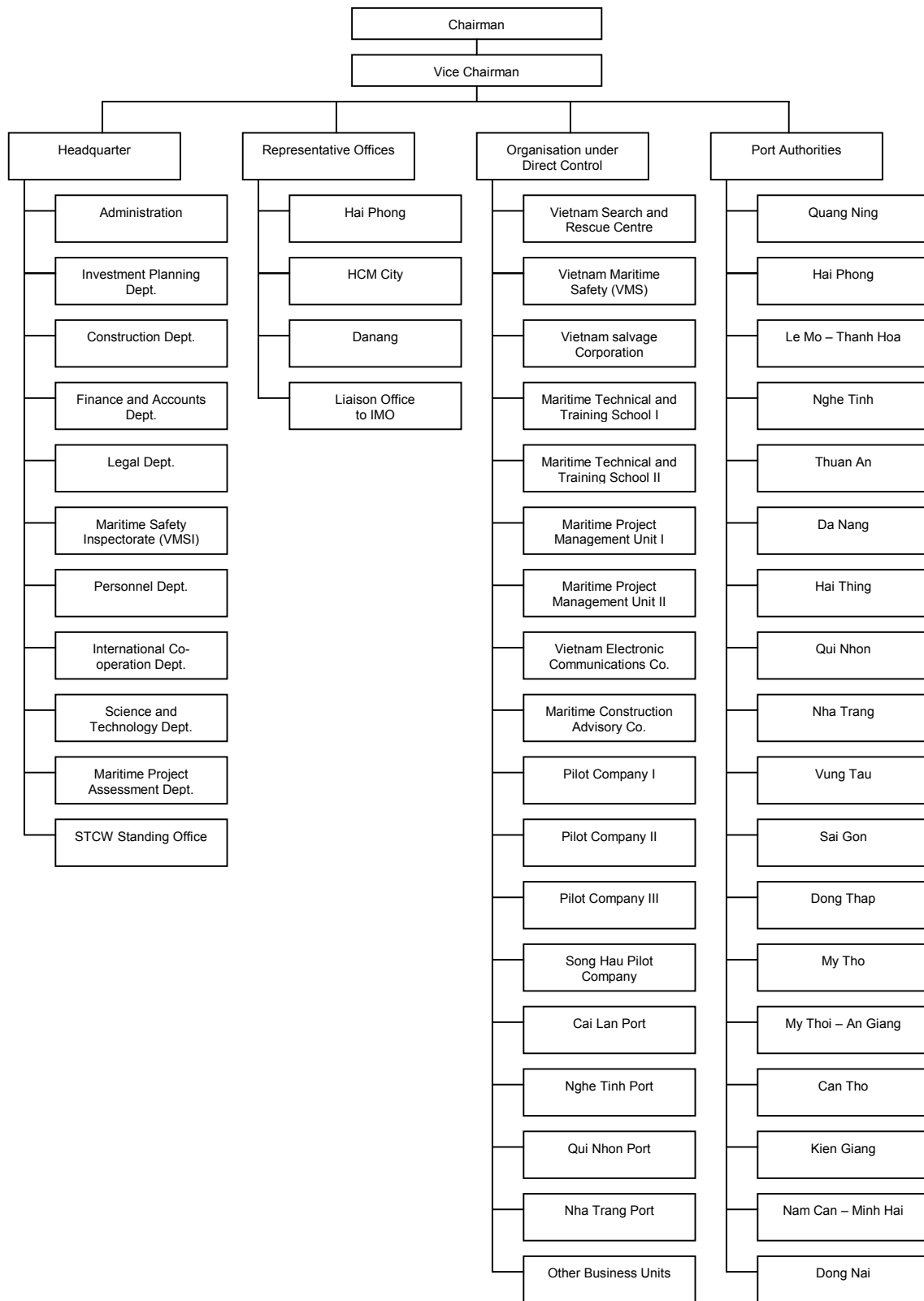

Figure 3.3: Organisation Chart of VINAMARINE

(Source: VINAMARINE, 1998)

The port authorities are delegated to monitor enforcement of maritime rules and regulations, including those covering maritime safety, environmental protection and maritime sanitation in all Vietnamese seaways and seaports. The VMS is an implementation agency responsible for providing Aids to Navigation (ATN) services along the coast and along rivers connecting inland ports designated by the MOT as seaports. The remaining non-regulatory functions of the VINAMARINE include operational management of

- the ports of Cai Lan, Nghe Tinh, Qui Nhon and Nha trang,
- the Pilot Companies I, II, III and Song Hau Pilot company, and
- the Vietnam Maritime Commercial Stock Bank (Maritime Bank).

It is understood that it is the government's intention, eventually, to divest these operational functions. The Prime Minister Decision No. 31/TTg dated 2 February 1993 defines VINAMARINE's responsibilities as

- (1) to develop plans for the marine industry and acting as owner of state maritime infrastructure
- (2) to develop maritime law
- (3) to propose policy on international maritime relations and manage international maritime projects and control operation of foreign maritime organisations
- (4) to undertake activities to ensure maritime safety
- (5) to undertake administration of sea-going vessels and operations, seaport and navigational aids through developing plans, issuing licences, managing infrastructure in accordance with government instruction, and providing search and rescue services

The VINAMARINE is currently not well equipped to perform its role because certain departments have not yet been systematically organised and staffed with people who have the necessary skills. Following the transfer of management and staff to the

VINALINES there are particular weaknesses in the Investment Planning, Legal and Safety Inspection Departments. The following two examples indicate this problem.

- (1) The Maritime Safety Inspectorate (VMSI) in the Maritime Safety Inspection Department is responsible for safety inspections of all sea-going ships in Vietnamese water and is supposed to have inspectors in the head office and the three regional offices. Although it has three staff members in the Hanoi head office and has assigned a Central Marine Safety chief Officer to the Hai Phong regional office, no one is currently assigned to Ho Chi Minh and Da Nang. Administration procedures for VMSI have still to be set up.
- (2) Vietnam has agreed in the Memorandum of Understanding on Port State Control in the Asia-Pacific Region, signed on 1 December 1993, to increase inspection activities in its territory, so that sub-standard ships can be prevented from operating in the region. However, the inspectors who are to enforce this undertaking in Vietnam have not been properly prepared to carry out this task.

3.1.1.3 Co-operation between Coastal Shipping and Inland Waterways

The Inland Waterway Bureau (IWB) was established on 30 January 1993 and is responsible for administration of inland waterway transport in Vietnam. The IWB is mandated mainly to supervise waterborne transport along rivers, lakes and river ports. In the past it was also mandated directly to manage inland waterway transport and river services. However, it is expected that these functions will be divested to allow the IWB to concentrate on its regulatory function. Figure 3.4 shows the overall organisation of IWB.

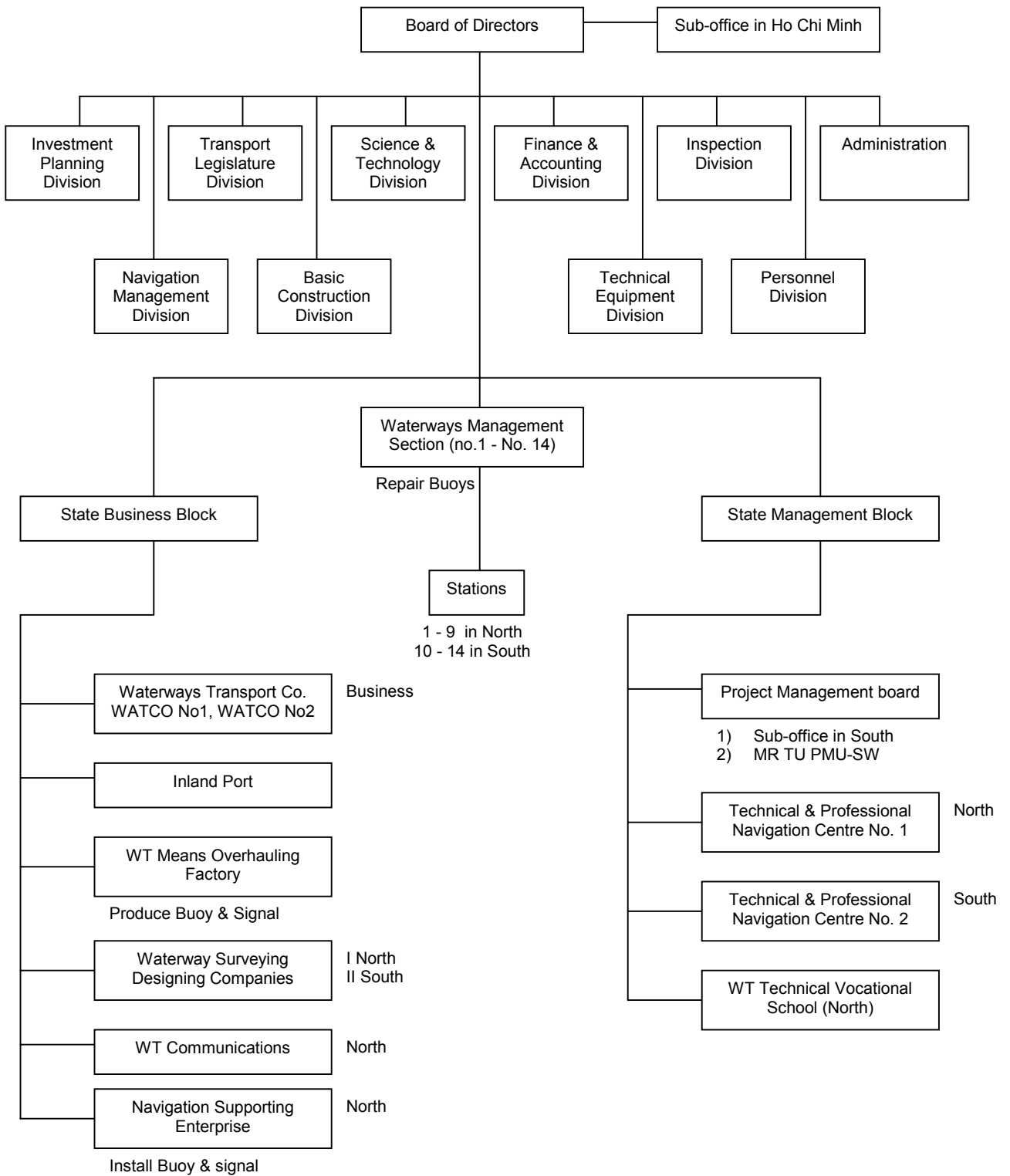

Figure 3.4: Organisation Chart of Inland Waterway Bureau (IWB)
 (Source: IBW, 1998)

The VINAMARINE used to administer part of the rivers but the IWB is now responsible for provision of infrastructure for all river waters after the issuance of the Government Decree No. 08-CP, dated 30 January 1993. The Union of Inland Waterway Management is the agency responsible to IWB for ATN and dredging along rivers (6,787 km of which are classified as navigable). However, since the VMS, under the control of the VINAMARINE, still manages ATN and dredging along 5 rivers serving inland seaports, the future physical demarcation between the IWB and the VINAMARINE is unclear. A similar problem arises over ports which are classified as either seaports or river ports. There are no consistent criteria applied to distinguish these two types of ports, resulting in both types of ports coexisting along the same stretch of river. Furthermore, inland ports such as Hanoi, which are potentially important for coastal shipping in the north, are still administered by IWB, while the most similar inland ports in the south are administered by VINAMARINE.

Responsibility for regulating vessels is generally rather clear--with VINAMARINE being responsible for larger or sea-going vessels. However, small inland waterway vessels regulated by the IWB are permitted to operate in coastal waters within 12 miles of the coast, and this results in most coastal passenger services being regulated by the IWB even though these are of particular safety concern.

It is clear that since sea-going and inland water vessels often use the same waterway and ports, either along rivers or along coastal waters, monitoring and enforcement functions could involve unnecessary duplication of effort by the IWB and the VINAMARINE. There is a danger that, through lack of co-ordination, monitoring and control is ineffective. For the same reason, there is a danger of inadequate planning of infrastructure and maintenance resulting from poor co-ordination between the two bodies.

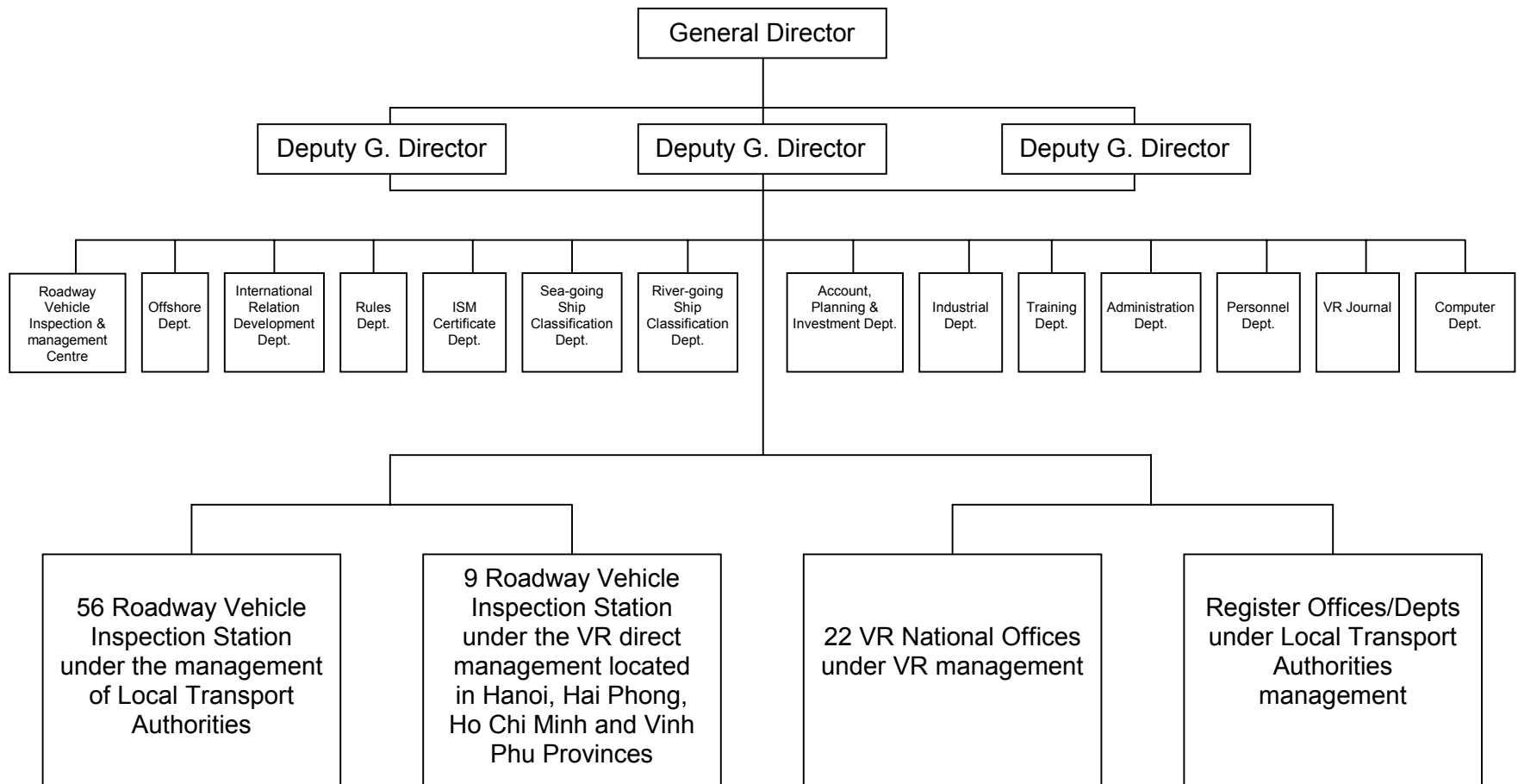

Figure 2.5: Organisation Chart of Vietnam Register (VR)

(Source: Hai Bang, 1999)

3.1.1.4 Role of Vietnam Register (VR)

The Vietnam Register (VR) was founded in 1964. The head office is in Hanoi (it was in Hai Phong before May 1998) and 22 offices are distributed countrywide. The VR has 380 technical staff, including 200 surveyors specialised on sea-going ships. The organisation chart is shown in Figure 2.5. The VR has newly established two departments (1996)--the Ship Safety Management Department and the Internal Quality Audit Department--due to the fact that Vietnam has to comply with the requirements of the new chapter IX of SOLAS as embodied in the International Safety Management (ISM) Code.

The VR is designed as a ship registration body with responsibilities that include technical supervision, classification, tonnage measurement and issuance of ship certificates. The VR is required to inspect ships and issues technical certificates in compliance with the international conventions which the Vietnamese Government is a party to. This means that the VR functions not only as a governmental body but also as an international recognised authorised classification society in Vietnam.

Implementing these new responsibilities places institutional demands on the VR that are difficult to meet because of the lack of trained personnel. At the same time there is a need to implement new registration procedures. The existing one was prepared and based on an internal regulation in 1964 which based on the former USSR Register of Shipping, but this has become outdated and needs to be amended. The VR recently started the revision work.

3.1.2 Rules and Regulations

3.1.2.1 Maritime Code

The legal basis for regulating maritime shipping activities, including coastal shipping, is defined in States Council Decree No. 42-LCT/HDNN8 dated 12 July 1990, and is referred to as the Vietnamese Maritime Code. The Code is mainly intended to cover activities of the Vietnamese ships (excluding those used exclusively for military purposes), and also includes certain provisions for foreign ships. The Code consists of 18 chapters, namely

- Chapter I: General Provisions
- Chapter II: Sea-going Vessel
- Chapter III: Shipcrew
- Chapter IV: Seaport and Port Authority
- Chapter V: Contract of Carriage of Cargo
- Chapter VI: Contract of Carriage of Passengers and of Luggage
- Chapter VII: Charter Parties
- Chapter VIII: Ship's Agent and Shipbroker
- Chapter IX: Maritime Pilotage
- Chapter X: Towage Service on Sea
- Chapter XI: Maritime Salvage
- Chapter XII: Recover of Property from the Sea
- Chapter XIII: Collision
- Chapter XIV: General Average
- Chapter XV: Civil Liability of Shipowner
- Chapter XVI: Contract of Marine Insurance
- Chapter XVII: Settlement of Maritime Disputes
- Chapter XVIII: Final Provisions

3.1.2.2 International Conventions

The Code enables the safety standard to be based on international practice by allowing international treaties to apply where these do not conflict with the Vietnamese Maritime Code. Vietnam has become IMO member in 1984. Since then, Vietnam has participated in 6 out of 78 effective IMO conventions

- (1) International Convention for the Safety of Life at Sea (1960, 1974, Protocol 1978)
 - SOLAS 60: 26 May 1965
 - SOLAS 74: 18 March 1991
 - SOLAS Protocol 78: 12 January 1993
- (2) International Convention for the Prevention of Pollution from Ships 1973 as Modified by Protocol 1978 (Annex I and II)
 - MARPOL 1973/1978: 29 August 1991
- (3) International Convention on Load lines, 1966
 - LOAD LINES 1966: 18 March 1991
- (4) International Convention on Tonnage Measurement of Ships, 1969
 - TONNAGE 1969: 18 March 1991
- (5) International Convention on Standard of Training, Certification and Watchkeeping for Seafarers, 1978
 - STCW 1978: 18 December 1991
- (6) Convention on the International Regulation for Prevention Collisions at Sea, 1972,
 - COLREG 1972: 18 December 1990

Besides the IMO conventions, Vietnam has ratified one multilateral convention related to the maritime sector, that is the United Nations Convention on the Law of the Sea 1982 (UNCLOS 1982).

3.1.2.3 Other Decrees

In addition to the Vietnamese Maritime Code and the international treaties that Vietnam has ratified, a great amount of decrees and decisions have been produced by the Prime Minister Office, Ministries, the VINAMARINE and the VR to define the roles and functions of the VINAMARINE, the IWB, the VR and others, to instruct local agencies in matters relating to the maritime field.

The list of laws and regulations in the maritime transport sector are given in the Appendix 1.

3.1.3 Inspection System

3.1.3.1 General

Ship Inspection systems are basically related to ship construction processes and quality of equipment to be used on board and also with ship safety operations. The former is deeply concerned with quality management of shipyard and repair facilities, while the latter is depending upon ship owner policy of the quality system of their ship management. Also master's and his crew's recognition of safety of life at sea (SOLAS), prevention of pollution from ship (MARPOL) and other relevant conventions, rules, and regulations are to be applied.

3.1.3.2 Law and Regulations

In article 24 of the Vietnamese Maritime Code the government recognised the Vietnam Register (VR) as the governmental organisation to carry out the registration activities and also appointed the Vietnam Maritime Safety Inspectorate (VMSI) to inspect and verify ships from the viewpoint of maritime safety and prevention of pollution. However, detailed procedures and technical requirements of ship construction and equipment, and technical procedures for ship inspection during the construction and/or operation, and requirements of qualification of ship inspectors, do not appear in the Vietnam

Maritime Code. Furthermore, the implementing procedure of international conventions that the government has to ratify also does not appear in the Vietnamese Maritime Code.

On December 28, 1992, two government decisions concerning rules for the organisation and sea-going ship registration activities in Vietnam (No. 203 /TTg) and rules for the organisation and activities of Vietnam Maritime Safety Inspectorate (VMSI) (No. 204 /TTg) were enacted. These government decisions authorised VR to carry out the registration activities, i.e. technical supervision, classification, tonnage measurement and issuance of relevant certificates required by the international conventions that the government has ratified. The VMSI, belonging to the VINAMARINE, was authorised to carry out the maritime safety inspection and protection of environment from pollution caused by ships in territorial water (territorial sea and internal water) of Vietnam.

In accordance with article 59 of the Vietnamese Maritime Code, the powers and duties of Port Authorities around the country are “to supervise the fulfilment of the rules and regulations on maritime safety navigation, environmental pollution prevention and maritime sanitation”. Vietnam has signed the Tokyo MOU since December 1, 1993, when MOU was agreed on by the countries concerned, and the government agreed to eliminate all sub-standard ships from Asian-Pacific area. However, a systematic organisation of port state control officers has yet to be set up in Vietnam.

3.1.3.3 Ship Inspection

Material, equipment, inventor, machinery and welding materials to be used for ship construction and installation are not yet systematically approved by the VR due to the lack of supporting industry in Vietnam. Therefore shipyards are obliged to accept to use imported parts which have been approved by foreign governments or by one of the International Classification Society.

The classified data according to year of build are shown in Table 3.1 below.

Table 3.1: Number of Ships Registered under VR

Year of Build	Total Registered Ships		Ocean-going Ships	
	No.	GT.	No.	GT.
>1960	8	16,396	0	-
1961 -1970	51	97,440	8	30,099
1971 -1980	97	136,508	38	80,248
1981 -1985	66	82,140	14	53,474
1986 -1990	189	72,015	5	11,385
1991 -1995	86	33,968	6	8,288
Total	497	438,467	71	183,494

Source: Register of Ships, 1994 - 1995, VR

The VR, as the inspection agency responsible for early establishment of an international recognised maintenance workshop, has the duty to oversee the compliance of rules agreed upon in international conventions, for example, life-raft routine maintenance workshop, radio equipment (including GMDSS equipment) maintenance workshop, and oil reception facilities to prevent marine pollution.

The VR has no testing laboratory at present and can not carry out mechanical and non-destructive examination on its own. They have to request an outside institution and /or shipyard facilities for this purpose. However, those facilities are also not properly operated due to lack/unavailability of maintenance parts and equipment (original supplied from the former USSR and Eastern Europe countries). For this reason, the VR plans to establish a modern testing laboratory and to invite the co-operation of the Vietnam Maritime University (VMU) in Hai Phong city in the near future; but no financial support is expected at the moment.

The VR branch offices, which are also duly bound to conduct safety inspection onboard ships, also does not have enough equipment.

3.1.3.4 Training

The training curriculum for qualified VR surveyors is currently undergoing rescheduling. The VMSI and Port Authorities are looking to send the necessary number of staff to the Tokyo MOU PSC Officer Study Seminar.

3.2 Vietnamese Fleet

Table 3.2: Vietnamese Fleet Size Distribution by Type of Ships

Ship Size (DWT)	General Cargo Ship	Tanker	Passenger Ship
below 500	268 (60.9%)	6 (26.2%)	4 (100%)
500 – 999	33 (7.5%)	5 (21.7%)	-
1,000 – 1,999	68 (15.5%)	5 (21.7%)	-
2,000 – 2,999	13 (3.0%)	3 (13.0%)	-
3,000 – 3,999	9 (2.0%)	1 (4.3%)	-
4,000 – 4,999	12 (2.7%)	1(4.3%)	-
5,000 and above	37 (8.4%)	2(8.7%)	-
Total	440 (100%)	23 (100%)	4 (100%)

Source: Register of Ship 1994-1995, VR

The Vietnamese fleet is mainly operated by state-owned and joint venture shipping operators. But there are also a number of provincial shipping companies and private operators. As shown in Table 3.2, the majority of the general cargo ships, tankers and passenger ships are less than 500 DWT. Such vessels use diesel engines and have high operating costs.

The percentage of the specialised ships is very low in the sea going fleet, with only one specialised Ro-Ro ship, 17 small- and medium-size tankers, 2 multi-functional ships for carrying containers and 30 refrigerated ships which are, however, not in such condition that they can carry refrigerating containers.

Table 3.3: Age Distribution of Vietnamese Fleet

Ship Age (years)	General Cargo Ship	Tanker	Passenger Ship
Less than 5	79 (18.0%)	3 (13.0%)	-
5 – 10	175 (39.8%)	4 (17.4%)	2 (50.0%)
11 – 15	66 (15.0%)	1 (4.3%)	-
16 – 20	49 (11.1%)	6 (26.1%)	1 (25.0%)
21 – 25	57 (13.0%)	6 (26.1%)	1 (25.0%)
More than 25	14 (3.2%)	3 (13.0%)	-
Total	440 (100%)	23 (100%)	4 (100%)

Note:

- (1) General cargo ships include 18 refrigerated ships.
- (2) The average age of general cargo and tanker ships is as follows

Below 500 DWT	8.1 years
500 – 999 DWT	13.0 years
1,000 – 1,999 DWT	13.6 years
2,000 – 2,999 DWT	17.0 years
3,000 – 3,999 DWT	19.9 years
4,000 – 4,999 DWT	22.3 years
5,000 DWT and above	20.0 years

Source: Register of Ships 1994-1995, VR

The present standard of the fleet is very poor, having equipment and facilities which are outdated, with only little use being made of modern automation and specialised control systems. The operating efficiency of the main engines is low (using the old technology from Eastern Europe), incurring high operating and maintenance costs. Difficulty in

getting spare parts can result in vessels being laid up or ineffective repair leading to the unreliable service. As shown in Table 3.3, the fleet includes many old vessels--16% of general cargo ships and 39% of tankers are over 20 years old. The average age of the fleet is 11.3 years. But the age is double for the larger vessels which are usually acquired second-hand.

The high degree of obsolescence of the Vietnamese fleet makes it impossible, at present, to reach the technical standards stipulated by international conventions and legal requirements of other countries in the region. At the same time it restricts efficiency and productivity of the maritime industry.

3.3 Conclusion

Generally speaking, Vietnamese maritime administration is quite comprehensive. It covers almost all activities of the Vietnamese fleet and the maritime industry. However, it is far from complete to carry out all the functions that it attempts to due to shortcoming in the organisations and in the co-operation between them which create a number conflicts of interests within one organisation and among organisations. The above review of the Vietnamese maritime industry indicates that there are significant deficiencies that need to be improved in order to establish an effective regulatory system for coastal shipping. The main deficiencies are as follows:

- (1) The development of the VINAMARINE from a shipping management body into a regulatory agency is far from complete. This organisation does not have the human, technical or financial resources needed to perform its regulatory role, especially considering its new obligations arising from international agreements
- (2) The VINAMARINE retains important commercial activities such as port management and Maritime Bank management, which are inconsistent with its role as an independent regulator

- (3) There is a lack of a clear and logical division of responsibilities between the VINAMARINE and the IWB making it difficult to establish uniform regulatory standards and enforcement systems along rivers
- (4) Possibly for the same reason, there is an inadequate financing systems for navigation aids and maintenance of river-ways
- (5) The VMS has insufficient human, technical or financial resources to perform its responsibilities for maritime safety
- (6) Many implementing regulations in maritime transport have not yet been introduced, especially regarding access by the Vietnamese shipping operators to foreign routes and incorporating international agreement into international law

People usually say, "the issue that is aware is 50 % solved ". This chapter not only describes the overview of the Vietnam maritime industry but also wish to draw more attention to the ineffectiveness of Vietnam maritime administration as mentioned above.

Chapter 4

PORT STATE CONTROL IMPLEMENTATION: A VIETNAMESE APPROACH

4.1 General

Very early this year (1999) Vietnam became a member of the Asia Pacific Memorandum of Understanding on Port State Control (Tokyo MOU). Actually, long time before this event, Vietnam had been granted the observer status to the Tokyo MOU and had exercised some control over foreign ships calling at Vietnamese ports, but it had not been done systematically, and without co-operation with other countries in the region. At present, Vietnam is on process of establishing port State control system throughout the country aiming to harmonise with country members of the Tokyo MOU. There are many challenges in front, but Vietnam will have its way of doing.

4.2 Legislation

The Prime Minister's Decision No. 31/TTg, dated 02 February 1993 on issuing regulations on VINAMARINE organisation and operations, defined the responsibilities and authorities of VINAMARINE. Among other things, the decision requires the VINAMARINE be obliged to enforce the provisions of ratified international conventions for Vietnamese ships and ships calling at Vietnamese ports. Incorporating with the decision No. 31/TTg, the decision No. 204/TTg defines that the Vietnam Maritime Safety Inspectorate (VMSI), among other things, is authorised to monitor the implementation of all maritime regulations and

international conventions affecting Vietnamese and foreign ships that conduct activities in Vietnam. In short, the decisions provides the national legal basis for the VINAMARINE particularly the VMSI under the supervision of the VINAMARINE to carry out flag State monitoring and port State control in Vietnam. However, it is neither said in Vietnam Maritime Code nor in the minister's decisions that the VINAMARINE and VMSI must exercise port State control according to Tokyo MOU and Asia Pacific Port State Control Manual.

At the lower level, there is an agreement related to PSC matters--*Agreement between the VINAMARINE and the VR with regard to Co-operation on Port State Control Implementation*--signed on 14 August 1998. Among other things, it states that

Port Authority Officers and VR's surveyors in co-operation carry out PSC:

- Port Authority Officers are responsible to inspect: Registry Document, Manning Document, Competent Certificates of Officers and crew, and other ship's documents
- VR's surveyors are responsible for inspection of matters related to Technical Specification and Standards issuing by the Government and requirements under international conventions that Vietnam has ratified.

(VINAMARINE, 1998)

It seems that the above agreement contains an essential conflict because it allows the VR to take part in port State control inspection, which exclusively is a matter of the maritime administration. The VR although is part of the Vietnamese maritime administration, but it carries out functions of surveys and certifications of ships like a classification society. There are cases that ships flying flags other than Vietnamese flag are classed by the VR. Therefore, there certainly is a conflict of interests when the VR carry out concurrently classification society functions and port State control. Therefore, port State control should be exercised solely by VINAMARINE. This also agrees with what had been said in paragraph 2.4.3 of the Tokyo MOU: "The PSCOs and the persons assisting them should have no commercial interest..."

The Tokyo MOU text was adopted on 1 December 1993 and has been amended on 13 August 1997 and 3 June 1998. One of the paragraphs which were added to the original memorandum text in 1998--paragraph 2.4.3--says

the Authority as the port State will not impose standards on foreign ships that are in excess of standards applicable to ships flying the flag of that port State.

It is quite straight forward that a member of Tokyo MOU can not enforce requirements which have not been ratified by itself over foreign vessels. As mentioned in previous chapters, Vietnam has not ratified all the seven relevant instruments of Tokyo MOU. The remaining are ILO convention No. 147, Annexes III, IV and V of MARPOL 73/78. In conclusion, although Vietnam is a member of Tokyo MOU, it could not tighten the net to eliminate substandard ships before all seven relevant instruments are ratified. Therefore, it is desirable not only in respect of port State Control implementation but also in the view of flag State monitoring that the Vietnamese government go on to ratify ILO convention No. 147, Annexes III, IV and V of MARPOL 73/78.

4.3 Administrative Structure

Currently the Vietnam Maritime Safety Inspectorate (VMSI) is one department of the VINAMARINE. As defined in the Prime Minister Decision No. 204 /TTg, the VMSI has power to

- (1) monitor implementation of all maritime regulations and international conventions affecting Vietnamese and foreign ships that conduct activities in Vietnam,
- (2) inspect sea-going ships, their loads and equipment, port facilities, marine navigation and other related equipment,
- (3) order port authorities to investigate causes of accidents,
- (4) propose to the VINAMARINE measures to ensure maritime safety and environmental protection,
- (5) monitor safety standards of port authority activities, pilot and search and rescue services,

- (6) promote dissemination of knowledge concerning maritime safety and environmental protection.

As described and analysed in chapter 3, the VMSI is carrying out the work similar to flag State and port State control with the involvement of the VR. However, the VMSI has not been properly prepared to carry out its tasks. For example, it has insufficient human resources to have representative in Ho Chi Minh and Da Nang offices.

Vietnam has a long coastline of more than 3,260 km with many ports located along it. In order to administrate all the maritime activities, the VINAMARINE has set up 3 representative offices, which are the Hai Phong office in the north, the Da Nang office in the central part and Ho Chi Minh office in the south of Vietnam. These offices work under the commands of the VINAMARINE Chairman. Any requests by specialist departments, like VMSI or others, to the representative offices need to be endorsed by the Chairman. On one hand, this mechanism allows the Chairman, who is responsible to the Minister of Transport, to control in detail the activities of his subordinated departments. On the other hand, it creates a huge amount of paper work and the effectiveness therefore is very low. In addition, the Chairman sometimes is not the best expert in some aspects. Therefore, the decisions endorsed by the Chairman in those aspects may not be the best one. The point is that the VINAMARINE should be reorganised in the way that all the specialist departments get more independence in acting on their specialist aspects.

The VINAMARINE should allow the VMSI have permanent staff in the 3 representative offices or called VMSI regional offices, which are independent from the VINAMARINE regional offices. These VMSI regional offices are chaired by Regional Chief Inspectors, each should have one secretary for documentation work and a number of inspectors. The proposed structure is shown in Figure 4.1.

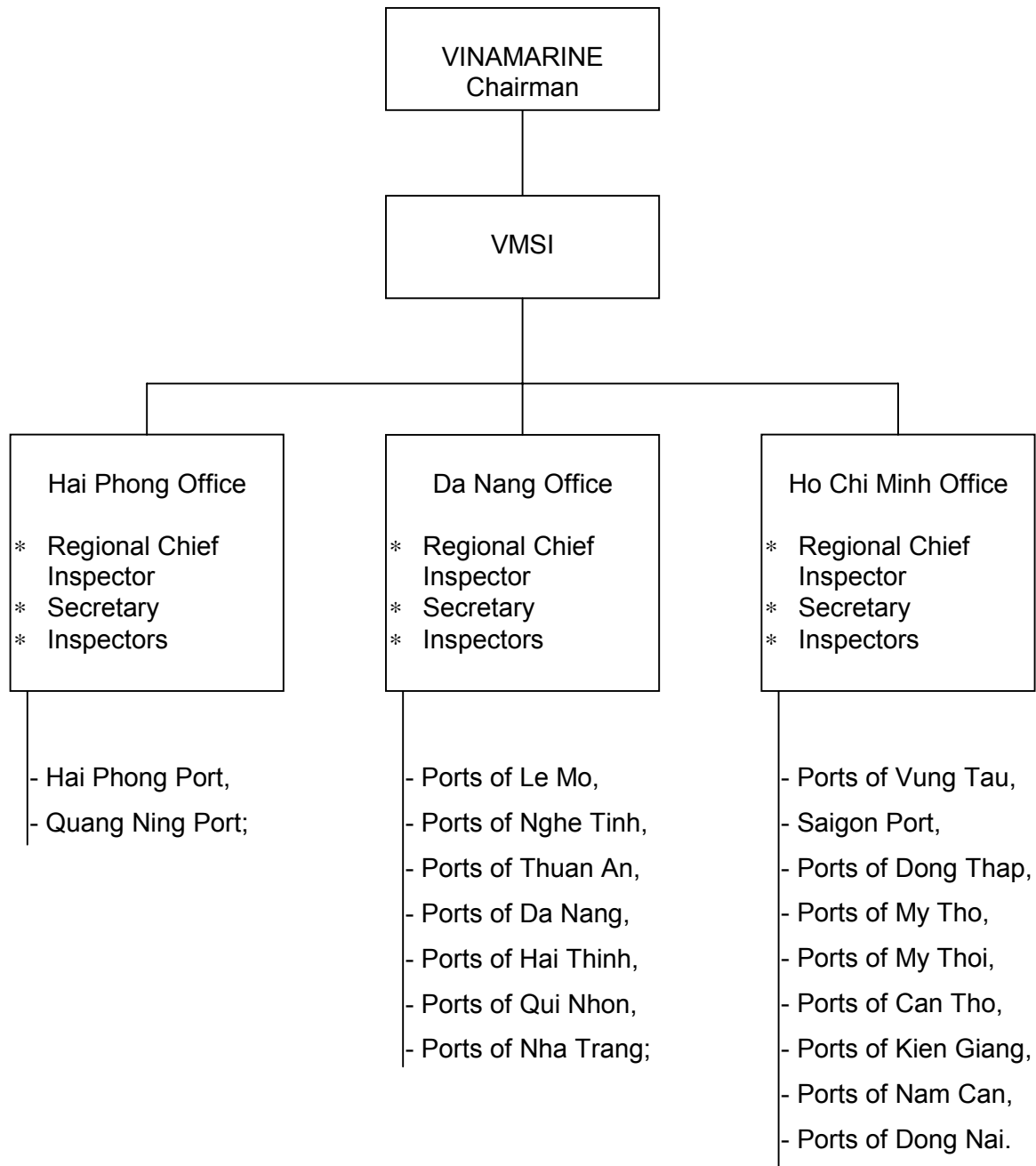

Figure 4.1: Proposed Structure of VMSI

4.4 Training

Naturally, training for PSCOs is a pure matter of the maritime administration, and it is also said in the memorandum "The Authorities will endeavour to establish training programs and seminars for port State control officers." In this case, the VINAMARINE must be responsible for training and employing their PSCOs.

4.4.1 Minimum Criteria for a PSCO:

First of all the VINAMARINE should be clear about criteria of PSCOs. According to Tokyo MOU, the PSC inspections will be carry out by properly qualified persons. The sections 2.4 and 2.5 of resolution A.787 (19) define qualified PSCOs *inter alia*

- (1) The PSCO should be experienced officer qualified as flag State surveyor
- (2) The PSCO should be able to communicate in English with the key crew
- (3) The PSCO should have necessary knowledge of the provisions of the applicable conventions, which are relevant to the conduct of port State control.

In context of Vietnam the following criteria for PSCO should be set up:

- (1) A PSCO must possess one of the following qualifications
 - a) A certificate of competence as master mariner in accordance with provisions of STCW 78, Reg. II/2, with shipboard experience and must have served onboard ship as chief officer.
 - b) A certificate of competence as chief engineer in accordance with provisions of STCW 78, Reg. III/2, with shipboard experience and must have served onboard ship as second engineer.
 - c) A master degree in Naval Architecture, with practical experience at a shipyard.
 - d) A certificate of competence as radio officer in accordance with provisions of STCW 78, Reg. IV/1,2, with shipboard experience and must have served onboard ship as Radio Officer (for radio surveyors).
- (2) A PSCO must show an evident of ability to communicate orally and in writing in English. For example, he holds

- a) An English C-level Certificate issued by the Hanoi National Foreign Language University, or
 - b) A TOEFL (Test of English as a Foreign Language) Certificate with score of 450 or above, or
 - c) An IELTS (International English Language Testing System) Certificate at band 4.5 or above, or
 - d) A First Certificate (FCE) or above of Cambridge Examination, or
 - e) He had studied in an English-speaking institute for 1 year or more.
- (3) A PSCO must have participated in a specialised training course for PSCO

4.4.2 Training Program

It is desirable for VINAMARINE to organise PSC courses in accordance to Model Course 3.09--Port State Control--recommended by the IMO. The outline of the model course is really focusing on the objectives following:

- identify the responsibilities of the flag State to exercise control over their ships and explain the role of a port State in supplementing such control;
- identify and correctly use those instruments available for port State control ;
- correctly identify and properly report to the flag State, IMO and ILO;
- maximise regional co-operation. (IMO, 1995c)

The teaching facilities and equipment required for the courses can be sufficiently supplied by the VINAMARINE. For the staff requirements, there are some senior inspectors in the VINAMARINE who can handle some parts of the course. In addition, the VINAMARINE should invite some senior surveyors from the VR.

Besides to organising PSC courses, the VINAMARINE should take advantages of having financed by international funds like SIDA or Sasakawa Foundation to send PSCOs to attend PSC courses in Tokyo (Japan) or Gothenburg (Sweden). The VINAMARINE should only send relevant people to attend the relevant course, and avoid sending administrative or financial people to the PSC courses.

4.5 Communication

In accordance with the Memorandum, a computerised database system, the Asia-Pacific Computerised Information System (APCIS) was established in Ottawa for reporting and storing port State inspection results and facilitating exchange of information in the region.

In Vietnam, the use of Internet is newly introduced and very costly. However, the VINAMARINE should make it available for PSCOs to access to the Asia-Pacific Computerised Information System (APCIS). It is very important that PSCOs can get information about ships calling at ports beforehand to plan their inspections effectively and professionally. In addition, through the APCIS the PSCOs can easily update their knowledge and also easily contact with other Authorities within Tokyo MOU.

Submission of Inspection Reports from PSCOs to VMSI through Regional Chief Inspectors should not be delayed due to any reasons. The VINAMARINE should establish communication routines with Tokyo MOU, IMO and ILO secretariats to ease submission of Inspection Reports to these organisations.

4.6 Procedure of Inspection, Rectification and Detention

In chapter 2, the port State control principles have been discussed. Generally, the port State control procedure can be summarised in the Figure 4.2--Flow chart of port State control.

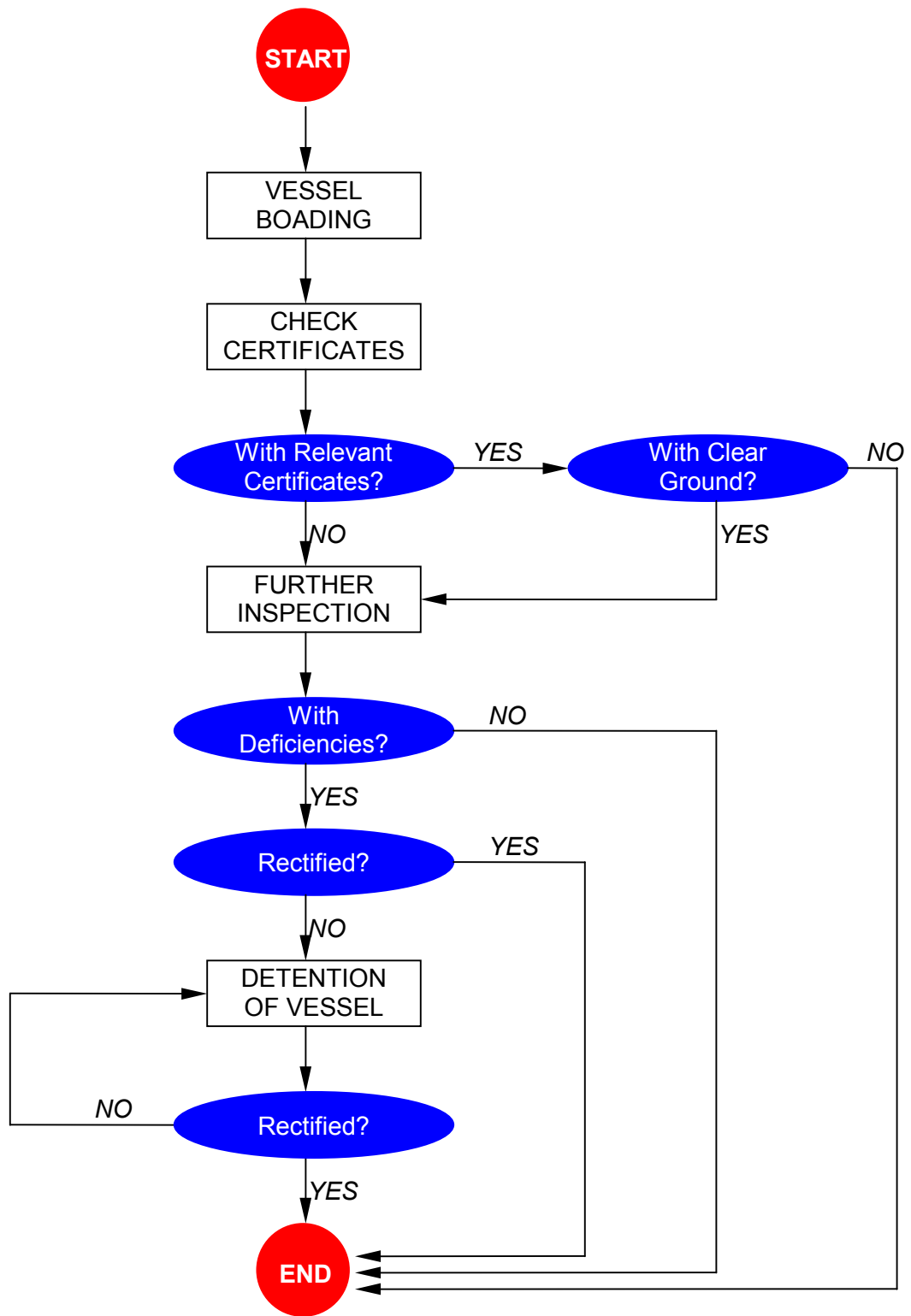

Figure 4.2: Flow Chart of Port State Control

Figure 4.3, made by the author with the references to two previous dissertations by Mr. Emmanuel B. Carppio and Ms. Marjorie Beatrice Dzifa Vormawah and taking into account the characteristic of the Vietnamese maritime administration, is attempted to recommend how PSCOs should conduct the port State control in Vietnam. The Figure 4.3 refers to some forms, some of which are shown in Appendix 3.

The inspected ships go through 3 different tracks due to the different seriousness of the deficiencies. When a PSCO verifies certificates and conducts cursory inspection, by professional judgement he categorises deficiencies as serious, slight or general. If the degree of deficiencies is *slight*, the PSCO will have oral warning to the master, then end the inspection after issuing Document of Check-off list (Form 02) and Inspection Reports (Form A & B).

In contrast, if the degree of deficiencies is *serious*, the master will be notified and the ship will not be allowed proceeding to sea until the deficiencies are rectified. Then the PSCO submits Inspection Report to Regional Chief Inspector and informs Port Authority of re-holding the ship. The Inspection Report will go through to VMSI, classification society, port operator, ship agent and owner. The VMSI is responsible for notifying in writing to the flag State local representative and the Tokyo MOU secretariat. The Tokyo MOU secretariat will communicate with IMO and ILO if appropriate.

The word "*general*" in this context means that the degree of deficiencies is in between serious and slight, the deficiencies can be rectified in the port or in the next port of call of the ship. The master must accomplish the nullification request to rectifying deficiencies in the port or the next port to call before the ship proceeding to sea. The PSCO then issues Document of Check-off list (Form 02) and Inspection Reports (Form A & B). In this case the next port of call is informed by a report from VMSI--*Report of Deficiencies Not Fully Rectified or Only Provisionally Repaired* (shown in Appendix 3). The confirmation of deficiencies rectification will probably be done by PSCOs of that port.

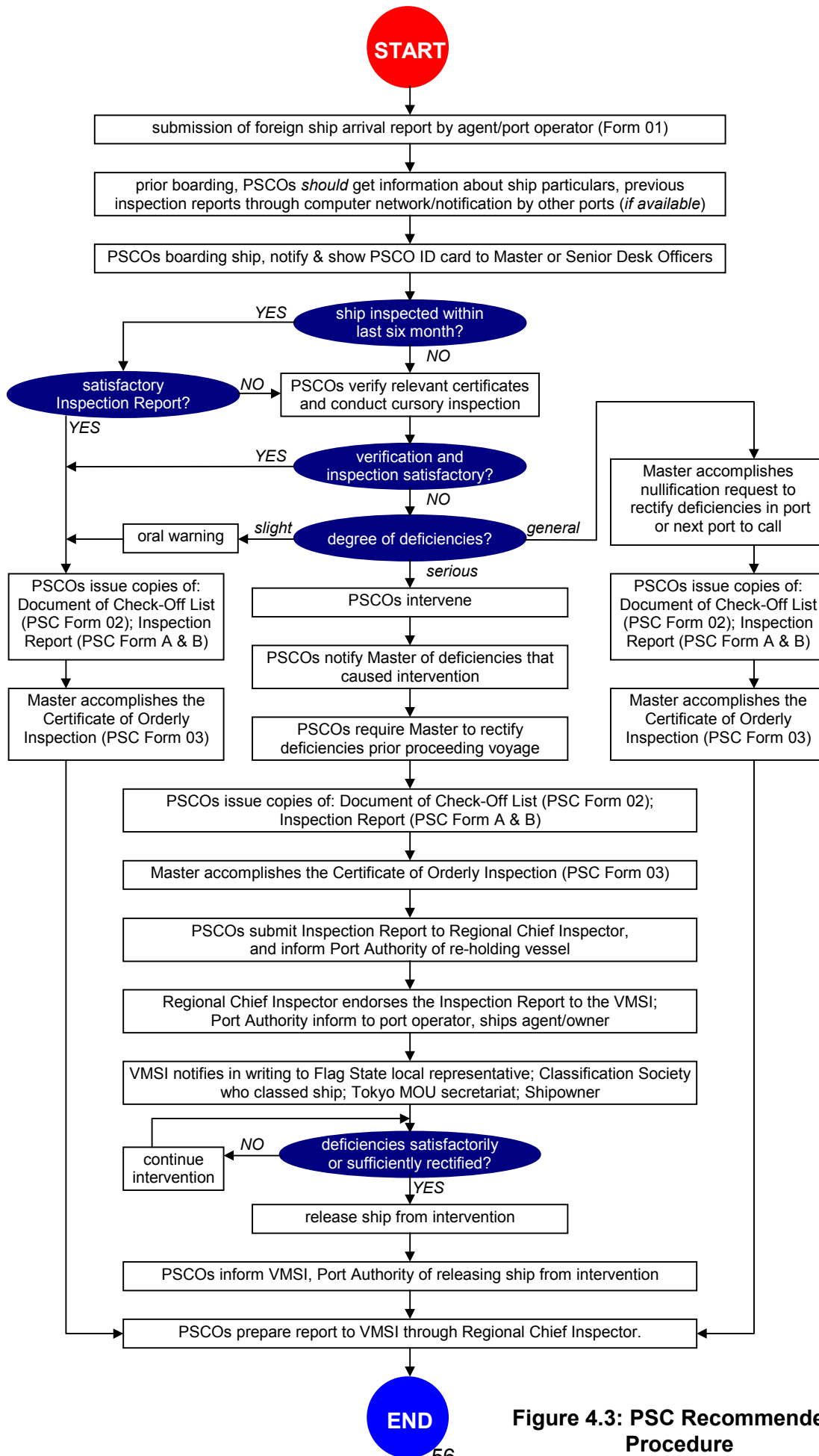

Figure 4.3: PSC Recommended Procedure

4.7 Conclusions

The chapter has presented one of the possible ways of implementation of port State control procedure in Vietnam. Some particular characteristics of Vietnam have been taken into consideration to build up the Vietnam approach. In which, PSC legal bases are proposed to create, administrative structure is also set up based on the current situation and the PSC practical procedure is developed.

Chapter 5

CONCLUSIONS AND RECOMMENDATIONS

5.1 Conclusions

As clearly said at the beginning, this dissertation has pursued three main objectives, which are the following:

- (1) To provide basic knowledge and principles of the port State control mechanism in a transparent way;
- (2) To identify difficulties in the process of setting up port State control in Vietnam, and to propose a Vietnamese approach to implement the PSC procedure;
- (3) To draw some recommendations for improving the efficiency and effectiveness of the Vietnamese maritime administration and improving the port State control procedure implementation in Vietnam.

Through the analyses in chapter 2, the port State control mechanism can be seen to be effective for enforcing IMO conventions, which raise up minimum standards for shipping. A ship is only subject to the national legislation of only one state, as long as it participates in domestic trade. In this case, the implementation of IMO conventions is voluntary for each state, and the PSC mechanism will never work if ships are not engaged in international trade. Due to the very international character of shipping, when a ship is calling at a port of another state, it not only is subject to the flag State legislation but also must fulfil requirements of the port State, which, according to UNCLOS, must not go beyond the international acceptance. Based on this nature, port State control procedure is developed.

Port State control is a comprehensive mechanism involving and imposing responsibilities to four parties, namely the national administration, classification societies, owners and the crew. Through practical experience, the best implementation of PSC is on a regional basis. Therefore, regional agreements on PSC have gradually appeared: Paris MOU in 1982, Latin American Agreement (Acuerdo de Viña del Mar) in 1992, Tokyo MOU in 1993, Caribbean MOU in 1996, Mediterranean MOU in 1997, Indian Ocean MOU in 1998 and the West and Central African MOU is scheduled to be adopted on October 1999 (IMO News, 1999).

By looking at the Vietnam maritime administration, Chapter 3 analysed the situation and figured out problem areas of the maritime administration, which are summarised in 3.3 of the same chapter. Those deficiencies should be made well aware of and eradicated.

After studying the principles of the PSC mechanism and analysing the situation of the Vietnamese maritime administration, it is concrete in Chapter 4, which built up a Vietnamese approach to implementing PSC procedure. The chapter mentioned the changes in legislation in respect of PSC and the setting up of administrative structure with the introduction of VMSI regional offices. The practical procedure for PSCOs to carry out inspections onboard was also described in the same chapter.

5.2 Recommendations

A crucial point is that in order to implement and enforce IMO safety and pollution prevention conventions and protocols and for the effective application of PSC, state ratifying IMO conventions - and those carrying out PSC - should have efficient maritime Administrations, staffed by well-trained, reasonably well-paid and experienced personnel.

(Plaza, 1997,30)

There is one point that is very interesting in the above statement of Mr Fernando Plaza, that is, to be a good port State, first of all the State must be a good flag State. Therefore, although the dissertation is dealing with PSC matters, this part of the dissertation attempts to present some recommendations concerning improvement of efficiency and effectiveness of the whole Vietnamese maritime administration toward a healthy industry, which has the potential capacity of development in Vietnam. The recommendations include suggestions in matters of legislation, maritime administration, classification societies and maritime operators in Vietnam.

5.2.1 Legislation

As mentioned in chapter 2, the Vietnamese maritime industry is governed by the Vietnamese Maritime Code, which was approved by the parliament in 1991, and the four volumes of the Collection of Maritime Law Documents, which are generated by the Prime Minister Office, Ministries, the VINAMARINE and the VR. Incorporating with national legislation, some international conventions that have been ratified by the government also govern the industry. Two examples below illustrate shortcomings in maritime legislation:

- Some decisions and decrees contained in the four volumes over-ruled the Vietnamese Maritime Code. Despite of that, neither the Vietnamese Maritime Code is amended nor those decisions and decrees are suspended.
- Vietnam is a dualistic legislation country, i.e. international conventions ratified by the government are not automatically in force in Vietnam until they are approved by the parliament. In fact, some of these international conventions, after being ratified, were discussed and approved by the parliament and some were not. In addition, the implementing procedure of an international convention is not defined in the Vietnamese Maritime Code

In short, it is very likely that the maritime laws and regulations are loosely organised, and this is a constraint for operational side and for those who wish to invest in the maritime industry.

The author's recommendations for the maritime legislation are the following:

- (1) The VINAMARINE should work in co-operation with the VR to produce an updated Maritime Code by recompiling the current Vietnamese maritime Code with the four volumes of decrees and decisions and international conventions that have been ratified by the government. It should then be proposed for approval of the parliament.
- (2) The updated Vietnamese Maritime Code should rectify shortcomings of the current Code. For example, definitions and procedures should be defined clearly in detail to avoid misleading interpretations.

In respect of port State control implementation:

- (3) The VINAMARINE should provide the translations in Vietnamese of the resolutions A.787 (19), Tokyo MOU and PSC manual to port authorities and other VINAMARINE's bodies. This should not be done in the current manner; that is the VINAMARINE sent directly the resolution A.787 (19) in English to the port authorities with a decision of the Chairman (The Quang, 1999) and let each port authority translate and understand in its own way, whereas those interpretations may not well be similar to each other.
- (4) Vietnam government should ratify the Annexes III, IV, V of MARPOL and ILO Convention No 147, because they are included in the seven relevant instruments of Tokyo MOU. This consequently facilitates harmonisation of PSC procedures.

5.2.2 Maritime Administration

The VINAMARINE is currently involved too much in commercial operations. Once the administration is doing commercial operations, there are certainly conflicts of interests, and the organisation can fulfil neither regulatory functions nor operational functions. The VINAMARINE, acting as the Vietnamese maritime administration, should have purely regulatory functions.

As analysed before, there is overlap between the scope of the VINAMARINE and the IWB. This certainly causes inefficiency of the two organisations.

It is recommended that

- (5) MOT should divest commercial operational functions of VINAMARINE to avoid conflict of interests when it carries out concurrently commercial, operational and regulatory functions.
- (6) The MOT should clearly define the functions and scopes of VINAMARINE and IWB. The idea to make the two organisations into one organisation governing maritime transport and inland transport should be considered.
- (7) The VINAMARINE should set standards for recruitment of staff and organise opening competitions for people who would like to be employed by the organisation. In other words, good communication with public expertise in the whole country should be maintained with regard to employment.
- (8) The VINAMARINE should seek for WMU graduates because they have been equipped with knowledge of international maritime aspects and have witnessed a number of maritime administrations in a number of developed countries and maritime power.

In respect of port State control implementation:

(9) As analysed in Chapter 4, the VINAMARINE and the VR should cancel their agreement signed on 14 August 1998--*Agreement between the VINAMARINE and The VR with regard of co-operation on PSC implementation*. The PSC inspections should be carried out solely by the VINAMARINE.

(10)The VINAMARINE should have its own PSCOs who have enough experience to carry out PSC inspections alone or in teams. This again is related to employment and recruitment matters. The VINAMARINE should set the criteria and communicate with the public in order to have employees fit for PSC inspections.

(11)The VINAMARINE should organise training courses for PSCOs according to IMO Model Course 3.09--'Port State Control'.

5.2.3 Classification Society

As mentioned in the previous chapter, the VR plays a combination role as a classification society and as part of the maritime administration in Vietnam. Therefore, almost all of the Vietnamese fleet are classified by the VR. In the Tokyo MOU annual reports, Vietnam very often appears with the highest percentage of ship detained. This is an indication not only of deficiencies in flag State control but also of the classification society which classifies Vietnamese ships, which is the VR.

(12)There are two options which served as solutions for the Vietnamese maritime administration, particularly to the MOT and VINAMARINE, to improve the situation:

- .1 Let the VR plays the Combination role; at the same time, improve the VR by upgrading working facilities, building laboratories, installing a computerised system, etc., and setting up a training program for surveyors and tightly controlling the entrance level for surveyors.

.2 Eliminate the administrative functions of the VR; let the VR operate as a pure classification society. Surveys and certification will be delegated to a number of classification societies, including the VR. By doing this, a free competitive environment for classification societies will be created. Naturally, Vietnamese ships will be classified by better classification societies. The VR may well be one of them, if it finds the way to improve itself. And this is very likely to happen.

By either solution, the classification of ships will consequently be improved. However, the author feels in favour of the second solution, which is less expensive and lessens the workload of the Administration. Nowadays, it usually appears that the Administrations do not have sufficient expertise and resources to carry out classification and certification for their ships, but they delegate to the recognised organisations.

5.2.4 Operators

The recommendations to Vietnam maritime operators are following:

(13) Vietnamese shipping companies, especially the VINALINES, should participate actively in international maritime forum, that is that they should be members of shipping associations like the International Association of Independent Tanker Owners (INTERTANKO), the International Chamber of Shipping (ICS) and the International Shipping Federation (ISF). By doing this, shipping companies can not only have their interests protected by shipping associations but also receive instruction to comply with new international requirements to avoid their ships being detained by port States.

(14) The VINASHIN and all shipyards should maintain good communication with VINAMARINE and IMO to update the ship design and construction requirements. Extend ability and capability to build ships that meet all the requirements under international conventions, to promptly repair deficiencies of ship calling in Vietnamese ports. To achieve this, Vietnamese shipyards should

strengthen the relationships and co-operation with shipyards in other countries to exchange technology and personnel and to accumulate the know-how.

BIBLIOGRAPHY

Clarke, Anthony (1994). 'Port State Control or Sub-standard Ships: Who is to blame? What is the cure?'. *Lloyd's Maritime and Commercial Law* . No 2, May, pp 202-209.

John Hare (1997). 'Port State Control: Strong Medicine to Cure a Sick Industry'. *Georgia Journal of International and Comparative Law--Special Admiralty Issue*, Vol. 26, No. 3, 1997

Kasoulides, GC (1993). *Port State Control and Jurisdiction: Evaluation of the Port State Regime*. London: Martinus Nijhoff Publishers.

Kim Viet, N (1995). *The Role of the Vietnam Register of Shipping (VIREs) in the Implementation of Maritime Safety*. MSc dissertation. Malmö, Sweden: The World Maritime University.

Ministry of Transport, Vietnam (MOT), Japan International Cooperation Agency (JICA), (1997). *Master Plan Study on Coastal Shipping Rehabilitation and Development Project in Vietnam*. Japan: JICA.

Mukherjee, PK (1998). 'Flag state, port state and coastal state jurisdictions'. *Government control*. Handout. World Maritime University. World Maritime University, Malmö, Sweden.

Parliament of the Socialist Republic of Vietnam (1991). *Vietnamese Maritime Code*. Hanoi: National Politics Publisher.

International Maritime Organisation (1997). *SOLAS and Consolidation 1997*. London: IMO.

International Maritime Organisation (1995a). *MARPOL 73/78*. London: IMO.

International Maritime Organisation (1995b). *Resolution A.787(19), Procedures for Port State Control*. London: IMO.

International Maritime Organisation (1995c). *Model Course 3.09: Port State Control*. London: IMO.

Jönsson, JÅ (1998). 'Port State Control'. *Port State Control*. Handout. World Maritime University. World Maritime University, Malmö, Sweden.

Tokyo MOU Secretariat (1997). *Annual Report 1997*. Tokyo: Tokyo MOU Secretariat

- The Quang, V (1999). Interview by the author. VINAMARINE, Hanoi, Vietnam.
- Ulstrup, A (1999). 'Port State Control'. *Field Study II*. Lectures. World Maritime University, Malmö, Sweden.
- United Nations (1982). *United Nations convention on the Law of the Sea*. New York: UN.
- Vietnam Ministry of Transport (1998). *Collection of Maritime Law Documents: Vol. I, II, III & IV*. Hanoi: MOT Publisher.
- VINAMARINE (1998). *Agreement between the VINAMARINE and the VR with regard to Co-operation on Port State Control Implementation*. Hanoi: VINAMERINE
- William O'Neil (1996). *World Maritime Day 1996*. IMO web-side: www/http/imo.org/. 29 march 1999.
- Xuan Vinh, C (1997). 'Some Problems in the Implementation of MARPOL 73/78 in Vietnam'. *VIREs magazine*. Volume 29 No 4, Pages 15-17.
- Xuan Manh, D (1993). *Maritime Safety Administration in Vietnam, Present Status and Recommendations*. MSc dissertation. Malmö, Sweden: The World Maritime University.

Appendix 1

LAWS AND REGULATIONS CONCERNED WITH MARITIME TRANSPORT

*(This appendix lists the decrees and decisions relevant to the
Maritime Transport Law as published in four volumes.)*

1. Collection of Maritime Law Documents, Volume I

2. No. 239/HDBT dated 29 June 1992: Decree of the Council of Minister on organising VINAMARINE. Page 100.
3. No. 31/TTg dated 02 February 1993: Government Prime Minister's decision on issuing regulations on VINAMARINE organisation and operations. Page 104.
4. No. 202/TTg dated 28 December 1992: Government Prime Minister's decision on issuing regulations on co-ordination of organisations which carry out the State-management at seaports in Vietnam. Page 117.
5. No. 204/TTg dated 28 December 1992: Government Prime Minister's decision on issuing regulations on ,maritime safety inspector's operations. Page 123.
6. No. 49/GD/VT dated 09 January 1993: Decision of Minister of Transport on regulations on maritime signal system. Page 134.
7. No. 203 / TTg dated 28 December 1992: Government Prime Minister's decision on issuing regulations on register of shipping in Vietnam. Page 150
8. No. 2917/QD/VT dated 25 December 1992: Decision of Minister of Transport on regulations of handling, receiving, delivering and maintaining cargoes at seaports in Vietnam. Page 167.

Collection of Maritime Law Documents, Volume II

1. Government's Declaration dated 25 May 1977 on the sea territory, adjoining area, economic and continental shell privileged are of Vietnam. Page 6.
2. Government's Declaration dated 12 November 1982 Base line utilised for calculating the width of territorial sea of Vietnam. Page 9
3. No. 30/CP dated 29 January 1980. Institutions allowing foreign ships to operate on the sea of Vietnam. Page 11.
4. No. 473/HDBT(Ministers Council): Institutions for foreign people and facilities to conduct fishery service within territorial sea of Vietnam. Page 23.
5. No. 239 QD/PC dated 9 February 1987: Regulations for seaport in Vietnam including regulations for port authority, Maritime inspection, port operation, entrance and exit of ships, navigation within the port, order, sanitary issues at pier and berth, use of safety boat. Page 34.
6. No. 3138 QD/PC 28 December 1979: Regulations for transit through Cuu Long river permitting transport of aids goods to Cambodia. Page 56.
7. No. 05/QD-BNV dated 1 July 1989: Regulations on the inland travel of foreign seafarers at frontier-pass port of Vietnam. Page 60.
8. No. 257/LB dated 12 December 1984. Regulations on the management of sea transport facilities of ship tax and foreign vessel arriving or leaving ports of Vietnam. Page 63.
9. No. 20/VGCP-CNTDDV dated 22 July 1993: Port charges. Page 70
10. No. 21/VGCP-CNTDDV dated 22 July 1993: On the maritime charges for waterway facilities transporting goods between the sea ports in Vietnam. Page 88.

11. No. 912/ VGCP-CNTDDV dated 23 October 1993 Regulations on the supplemental guidance for sea port charges. Page 95.
12. No. 2006/QD-PCHH dated 1 October 1993 Regulations on the forms to be applied in state administration at the sea ports. Page 102.
13. No. 39/QDBC dated 3 January 1974 Regulations on the rules for investigation and report of ship distress. Page 117
14. No. 1071 QD/PC dated 26 June 1981 Regulations on the regime for report and statistics of traffic distress. Page 121.
15. Decree of Transport Minister dated 14 May 1958 on the Haiphong, Hon Gai, Cam Pha, Ben Thuy ports. Page 161.
16. No. 1579 QD-PC dated 5 October 1981. Announcement of Quang Ning, Da Nang, Quy Nhon, Saigon ports and Hon Me berth. Page 163.
17. No. 678 QD/VT-BD dated 13 April 1991. Announcement of Hon Gai port. Page 165.
18. No. 1486 QD/VT-BD dated 28 July 1992. Announcement of Cam Pha port. Page 167.
19. No. 508 QD/LBGTVT-NL dated 2 April 1990. Management of Cam Pha port. Page 170.
20. No. 169/GTVT dated 13 August 1988. Announcement transshipment area in Hon Gai gulf. Page 176.
21. No. 493/QD-PCHH dated 4 September 1993. Announcement of Van Gia Transshipment area in Quang Ning. Page 178.
22. No. 536/QD-PCHH dated 17 September 1993. To allow entry and exit of ship at oil port B12. Page 178.
23. No. 553/QD-PCHH dated 10 October 1993. To allow entry and exit of ship at pier No. 1 at Cai Lan port. Page 180.
24. No. 2059/QD-PC dated 29 August 1988. Traffic safety on access and exit rout of Haiphong port. Page 183.
25. No. 1570/QD-VT dated 28 August 1990. Local and foreign ships to be allow to arrive at pier of Union of Sea Product Enterprise of Haiphong. Page 186.
26. No. 2389/QD-VT dated 27 November 1991. Permitting specialised ship transport oil petrol in and out of Thuong Ly oil port . Page 188.
27. No. 1315/QD-PC dated 24 July 1989. Thanh Hoa port. Page 191.
28. No. 538/QD-VT dated 23 March 1991. To allow entrance and exit of ships at Nghe Tinh port. Page 193.
29. No. 2316/QD-VT dated 15 November 1991. To allow entrance and exit of ships at Xuan Hai port Nge Tinh province. Page 196.
30. No. 594/QD-PCHH dated 20 October 1993 To allow entrance and exit of ships at pier of B port of Hai Son ship repair yard. Page 199.
31. No. 634/PCHH dated 22 November 1993. To allow entrance and exit of ships at Ky Hoa port. Page 202.
32. No. 162/PC dated 13 July 1987. Operation at Thi Vai port of Nghia Binh province. Page 205.
33. No. 2600/QD-PC dated 26 December 1989. Regarding duties of Hon Khoi port - Ninh Hoa - Khanh Hoa province. Page 207.
34. No. 2132/QD-VT dated 20 November 1990. Opening transshipment berth at Van Phong gulf - Hon Khoi - Khanh Hoa province. Page 196.
35. No. 2017/QD-VT dated 30 September 1990. Announcement of Ba Ngoi port - Khanh Hoa province to open for international vessels. Page 211.
36. No. 77/CT dated 19 March 1989. Management and operation of tan Cang in HCM city. Page 214.
37. No. 2028/QD-VT dated 02 November 1990. ships with Vietnamese passport are allowed to arrive at pier of Tan Cang port under Ministry of National Defence. Page 216.
38. No. 1834/QD-VT dated 6 October 1990. Local and overseas ships are allowed to arrive at pier of Ben Nghe port, HCM city. Page 218.
39. No. 549/QD-VT dated 29 March 1991. To allow entrance and exit of ships at East Tan Thuan port. Page 221.

40. No. 1392/QD-VT dated 19 July 1991. To allow entrance and exit of ships at H pier of Ba Son port. Page 223.
41. No. 1209/VT dated 24 June 1991. ships with tonnage less than 15 000 DWT to enter Nha Be on Nha Be river. Page 225.
42. No. 440/QD-VT dated 18 March 1992. To allow entrance and exit of ships at B pier of Ba Son port. Page 227.
43. No. 1133/QD-VT dated 22 June 1992. To allow entrance and exit of ships at dock No. 3 of Tan Cang port, Saigon. Page 229.
44. No. 1134/QD-VT dated 22 June 1992. To allow entrance and exit of oil tankers at B pier of Saigon Bridge PETRO. Page 231.
45. No. 1860/QD-VT dated 11 September 1992. To allow entrance and exit of specialised ships at PETECHIM port, Cat Lai. Page 233.
46. No. 2431/QD-VT dated 28 October 1992. To allow entrance and exit of ships at East Tan Thuan port under MOT. Page 235.
47. No. 1824/PCHH dated 27 August 1993. To allow entrance and exit of ships at VITRANCHART port. Page 237.
48. No. 53/ HDBT dated 14 March 1987. Establishment of Vung Tau port. Page 238.
49. No. 706/QD-PC dated 14 April 1987 Announcement of Vung Tau port. Page 240.
50. No. 545/QD-VT dated 27 March 1991. To allow entrance and exit of ships at Vung Tau oil branch port under Vung Tau port. Page 242.
51. No. 386/QD.GT dated 09 March 1992. To allow entrance and exit of ships at Cat Lo port, Ba Ria-Vung Tau. page 244.
52. No. 657/QD-PCHH dated 6 December 1993. To allow entrance and exit of ships at port for oil storage of Petro-technological Service Company. Page 246.
53. No. 1946/QD-PL dated 26 October 1990. To allow entrance and exit of ships at Dong Thap port . Page 249.
54. No. 4321/GTBD dated 23 September 1992. Announcement of Dong Nai commercial port. Page 251.
55. No. 2025/QD-VT dated 02 October 1992. Announcement of Dong Nai port under Dong Nai province to open for entrance and exit of local and overseas vessels. Page 252.
56. No. 3036/GTBD dated 15 July 1992. Announcement of Can Tho port open for entrance and exit of cargo vessels. Page 255.
57. No. 1463/QD-VT dated 25 July 1992. Announcement of Can Tho port under Can Tho province to open for entrance and exit of local and overseas vessels. Page 256.
58. No. 481/QD-PC dated 20 March 1989. Opening of My Thoi port, An Giang province. Page 258.
59. No. 1201/QD-VT dated 29 June 1990. Opening of Nam Can port, Minh Hai province. Page 260.
60. No. 1292/QD-CP dated 23 May 1988. Opening of Hon Chong port, Kien Giang province. Page 262.
61. No. 1333/QD-PCVT dated 1 July 1993. Water area of Quang Ninh port and area under responsibilities of Quang Ninh Port Authority. Page 265.
62. No. 734/QD-PCVT dated 17 May 1993. Water area of Haiphong port and area under responsibilities of Haiphong Port Authority. Page 272.
63. No. 935/QD-PCVT dated 17 May 1993. Water area of Thanh Hoa port and area under responsibilities of Thanh Hoa Port Authority. Page 277.
64. No. 1330/QD-PCVT dated 3 July 1993. Water area of Nghe Tinh port and area under responsibilities of Nghe Tinh Port Authority. Page 280.
65. No. 1600/QD-PCVT dated 12 August 1993. Water area of Danang port and area under responsibilities of Danang Port Authority. Page 283.
66. No. 1601/QD-PCVT dated 12 August 1993. Water area of Qui Nhon port and area under responsibilities of Qui Nhon Port Authority. Page 286.
67. No. 1634/QD-PCVT dated 18 August 1993. Water area of Nha Trang port and area under responsibilities of Nha Trang Port Authority. Page 289.

68. No. 1331/QD-PCVT dated 2 July 1993. Water area of Saigon port and area under responsibilities of Saigon Port Authority. Page 292.
69. No. 1635/QD-PCVT dated 18 August 1993. Water area of Vung Tau port and area under responsibilities of Vung Tau Port Authority. Page 296.
70. No. 1399/QD-PCVT dated 12 July 1993. Water area of Dong Thap port and area under responsibilities of Dong Thap Port Authority. Page 300.
71. No. 936/QD-PCVT dated 17 May 1993. Water area of Can Tho port and area under responsibilities of Can Tho Port Authority. Page 303.
72. No. 1401/QD-PCVT dated 12 July 1993. Water area of My Thoi port and area under responsibilities of My Thoi Port Authority. Page 305.
73. No. 1400/QD-PCVT dated 12 July 1993. Water area of Nam Can port and area under responsibilities of Nam Can Port Authority. Page 308.

Collection of Maritime Law Documents, Volume III

1. No. 13/CP dated 25 February 1994. Government decree on issuing management regulations on maritime operations at seaports and maritime areas in Vietnam. Page 6.
2. No. 14/CP dated 25 February 1994. Government decree on issuing registered regulations for ships and seafarers. Page 39.
3. No. 22/CP dated 22 March 1994. Government decree on state-management duties, rights and responsibilities and organisation of Ministry of Transport. Page 65.
4. No. 174/QD-PCVT. Decision of Minister of Transport on issuing regulations on seafarer's position and responsibilities in Vietnamese ships. Page 69.
5. No. 1299/QD-TCCB-LD dated 29 June 1993. Decision of Minister of Transport on issuing regulations on organising examinations issuing degrees for seafarers in Vietnamese ships.
6. No. 256/PCHH dated 23 April 1994. Decision of Chairman of VINAMARINE on classification and implementation of operation of registering organisations for ships and seafarers. Page 177.
7. No. 174/QD-PC Dated 08 September 1994. Decision of Minister of Transport on procedures on "maritime claims" in Vietnam. Page 185.
8. No. 2884/QD-PC dated 17 November 1994. Decision of Minister of Transport on procedures on maritime pilotage, standards for organising exams and issuing certificates for Vietnamese maritime pilots. Page 191.

Collection of Maritime Law Documents, Volume IV

1. Decree No. 91/CP dated 23 August 1997 of Government on issuing regulations of registration of ships and crew.
2. Decree No 55/CP dated 01 October 1996 of government on activities of foreign military vessels visiting the Socialist Republic of Vietnam.
3. Decision No. 780/TTg dated 23 October 1996 of Prime Minister on establishment of the National Committee on air and sea search and rescuer.
4. Decision No. 639/TTg dated 12 August 1997 of Prime Minister on organisation, rights, duties and obligations of Maritime Port Authorities.
5. Decision No. 75/TTg dated 03 February 1997 of Prime Minister on rights, obligations and organisation of the Vietnam Register.
6. Decision No. 250/TTg dated 29 April 1995 of Prime Minister on establishment of VINALINES
7. Decree No. 79/CP dated 22 November 1995 of government on approval of statutory of organisation and activities of VINALINES.
8. Decision No. 69/TTg dated 31 January 1996 of Prime Minister on establishment of VINASHIN
9. Decree No. 33/CP dated 27 May 1996 of government on approval of statutory of organisation and activities of VINASHIN.

10. Decision No. 1438/QD-CP dated 8 September 1994 of Ministry of Transport on procedure of maritime liens and mortgages.
11. Decision No. 2788/QD-CP dated 17 May 1995 of Ministry of Transport on foreign vessels carrying cargo, passengers and luggage between Vietnamese ports.
12. Decision No. 4276/QD-CP dated 27 September 1995 of Ministry of Transport on contribution of salvage remuneration of Vietnamese ships.
13. Decision No. 2054/QD-CP dated 6 August 1996 of Ministry of Transport on procedure of setting up new route for passenger and cargo transport of foreign vessels in Vietnamese ports.
14. Decision No. 2106/QD-CP dated 23 August 1997 of Ministry of Transport on issuing regulations on loading, discharging, delivery and conserving goods at Vietnamese ports.
15. Decision No. 2628/QD-CP dated 02 October 1996 of Ministry of Transport on establishment of Co-ordinate Centre of Maritime Search and Rescuer.
16. Decision No. 127/VG-CP-NTD.DV dated 28 October 1997 of Governmental Price Committee on port dues.
17. Decision No. 128/VG-CP-NTD.DV dated 28 October 1997 of Governmental Price Committee on navigation fees of ships carrying cargo between Vietnamese ports.
18. Decision No. 129/VG-CP-NTD.DV dated 28 October 1997 of Governmental Price Committee on port dues with regard to certain special instances.
19. Decision No. 212/QD-PCHH dated 22 April 1995 of VINAMARINE on declaration of pier 1 of Cai Lan port.
20. Decision No. 1363/QD-PCHH dated 4 June 1997 of VINAMARINE on declaration of oil port B12.
21. Decision No. 32/QD-PCHH dated 06 June 1997 of VINAMARINE on declaration of Dong Hai port.
22. Decision No. 71/QD-PCHH dated 23 June 1997 of VINAMARINE on declaration of GAS Dai Hai port.
23. Decision No. 1278/QD-PC dated 16 May 1997 of VINAMARINE on carrying out procedure of allowing ship entry and exit at Haiphong port and Chinfon port.
24. Decision No. 187/QD-DKTBTV dated 20 September 1997 of VINAMARINE on declaration of Hai Dang port.
25. Decision No. 142/QD-PCHH dated 18 March 1995 of VINAMARINE on allowing lighters to entry and operate cargo handling at Chua Ve port.
26. Decision No. 183/QD-DKTBTV dated 17 September 1997 of VINAMARINE on declaration of pier No. 1 of Diem Dien port.
27. Decision No. 262/QD-PCHH dated 19 August 1996 of VINAMARINE on declaration of Nghi Huong port.
28. Decision No. 179/QD-PCHH dated 12 September 1997 of VINAMARINE on declaration of Gianh port.
29. Decision No. 313/QD-PCHH dated 14 June 1997 of VINAMARINE on declaration of K4-D6 port.
30. Decision No. 314/QD-PCHH dated 14 June 1995 of VINAMARINE on declaration of Lien Chieu port.
31. Decision No. 460/QD-PCHH dated 23 December 1995 of VINAMARINE on declaration of Sa Ky port.
32. Decision No. 02/QD-PCHH dated 05 January 1995 of VINAMARINE on declaration of pier B of Hai Son ship repairing yard.
33. Decision No. 437/QD-PCHH dated 14 December 1995 of VINAMARINE on declaration of Quy Nhon port for vessels of 10,000 DWT.
34. Decision No. 246/QD-PCHH dated 18 May 1995 of VINAMARINE on declaration of Quy Nhon port for oil tankers.
35. Decision No. 107/QD-PCHH dated 07 March 1995 of VINAMARINE on declaration of Nha Trang port.
36. Decision No. 423/QD-PCHH dated 12 December 1995 of VINAMARINE on declaration of port at Nha Be Petroleum Corporation.

37. Decision No. 248/QD-PCHH dated 19 May 1995 of VINAMARINE on declaration of port B of Saigon Petro.
38. Decision No. 246/QD-PCHH dated 18 May 1995 of VINAMARINE on declaration of port A of Saigon Petro.
39. Decision No. 656/QD-PCHH dated 20 September 1996 of VINAMARINE on declaration of Bong Sen port.
40. Decision No. 30/QD-PCHH dated 09 January 1996 of VINAMARINE on declaration of specialised port at Cat Lai.
41. Decision No. 1015/QD-PCHH dated 27 June 1995 of VINAMARINE on declaration of Go Dau port.
42. Decision No. 282/QD-PCHH dated 23 October 1995 of VINAMARINE on declaration of Long Thanh specialised port.
43. Decision No. 28/QD-PCHH dated 04 June 1997 of VINAMARINE on declaration of Phuoc Khanh specialised port.
44. Decision No. 47/QD-PCHH dated 17 June 1997 of VINAMARINE on declaration of GAS-PVC Phuoc Thai port.
45. Decision No. 387/QD-PCHH dated 03 September 1996 of VINAMARINE on declaration of Phu My port.
46. Decision No. 178/QD-PCHH dated 11 September 1995 of VINAMARINE on declaration of oil port at Phu My power plant.
47. Decision No. 684/QD-PCHH dated 24 March 1997 of VINAMARINE on declaration of port at Truong Sa SEAPRODEX Company.
48. Decision No. 766/QD-PCHH dated 02 October 1996 of VINAMARINE on temporary declaration of transshipment area at Go Gia.
49. Decision No. 44/QD-PCHH dated 23 January 1997 of VINAMARINE on allowing Vietnamese and foreign vessels calling on My Tho port.
50. Decision No. 21/QD-PCHH dated 03 June 1997 of VINAMARINE on declaration of Can Tho port.
51. Decision No. 519/QD-PCHH dated 18 September 1996 of VINAMARINE on declaration of X55 port.
52. Decision No. 1871/QD-PCHH dated 04 January 1997 of VINAMARINE on temporary declaration of transshipment area at Sa Dec
53. Decision No. 1362/QD-PCHH dated 04 June 1995 of VINAMARINE on declaration of anchoring positions at Hau river.
54. Decision No. 21/QD-PCHH dated 06 January 1995 of VINAMARINE on declaration of specialised port of Binh Tri.
55. Decision No. 935/QD-PCHH dated 19 October 1995 of VINAMARINE on temporary declaration of anchoring area for passenger ships at Phu Quoc sea area.

Appendix 2:

**MEMORANDUM OF UNDERSTANDING ON PORT STATE CONTROL
IN THE ASIA PACIFIC REGION**

The Maritime Authorities of

Australia

New Zealand

Canada

Papua New Guinea

People's Republic of China

Philippines

Fiji

Russian Federation

Hong Kong, China

Republic of Singapore

Indonesia

Solomon Islands

Japan

Thailand

Republic of Korea

Republic of Vanuatu

Malaysia

Socialist Republic of Vietnam

hereinafter referred to as "the Authorities"

Recognizing the importance of the safety of life at sea and in ports and the growing urgency of protecting the marine environment and its resources;

Recalling the importance of the requirements set out in the relevant maritime conventions for ensuring maritime safety and marine environment protection;

Recalling also the importance of the requirements for improving the living and working conditions at sea;

Noting the resolutions adopted by the International Maritime Organization (IMO), and especially Resolution A682(17) adopted at its 17th Assembly, concerning regional co-operation in the control of ships and discharges;

Noting also that the Memorandum is not a legally binding document and is not intended to impose any legal obligation on any of the Authorities;

Mindful that the principal responsibility for the effective application of standards laid down in international instruments rests upon the administrations whose flag a ship is entitled to fly;

Recognizing nevertheless that effective action by port States is required to prevent the operation of substandard ships;

Recognizing also the need to avoid distorting competition between ports;

Convinced of the necessity, for these purposes, of an improved and harmonized system of port State control and of strengthening cooperation and the exchange of information;

have reached the following understanding:

Section 1 General

- 1.1 Each Authority that has accepted the Memorandum will give effect to the provisions of the present Memorandum.
- 1.2 For the purposes of the Memorandum, references to the "region", to "regional", to "regional ports" or to "regional port State control" mean the Asia-Pacific region, and references to "port State" means the States, and the territories recognized as Associate Members of IMO in which the ports are located.
- 1.3 Each Authority will establish and maintain an effective system of port State control with a view to ensuring that, without discrimination, foreign merchant ships calling at a port of its Authority, or anchored off such a port comply with the standards laid down in the relevant instruments as defined in section 2.
- 1.4 Each Authority, under the coordination of the Committee established pursuant to paragraph 6.1, will determine an appropriate annual percentage of individual foreign merchant ships, hereinafter referred to as "ships", to be inspected. The Committee will monitor the overall inspection activity and its effectiveness throughout the region. As a preliminary target, subject to subsequent review, the Committee will endeavour to attain a regional annual inspection rate of 50% of the total number of ships operating in the region by the year 2000. The percentage is based on the number of ships which entered regional ports during a recent base period to be decided by the Committee.
- 1.5 Each Authority will consult, cooperate and exchange information with the other Authorities in order to further the aims of the Memorandum.

Section 2 Relevant Instruments

- 2.1 For the purposes of the Memorandum, the following are the relevant instruments on which regional port State control is based:
 - .1 the International Convention on Load Lines 1966;
 - .2 the International Convention for the Safety of Life at Sea, 1974 as amended;
 - .3 the Protocol of 1978 relating to the International Convention for the Safety of Life at Sea, 1974;
 - .4 the International Convention for the Prevention of Pollution from Ships 1973, as modified by the Protocol of 1978 relating thereto;
 - .5 the International Convention on Standards for Training, Certification and Watchkeeping for Seafarers, 1978, as amended;

- .6 the Convention on the International Regulations for Preventing Collisions at Sea, 1972;
 - .7 the International Convention on Tonnage Measurement of Ships, 1969; and
 - .8 the Merchant Shipping (Minimum Standards) Convention, 1976 (ILO Convention No. 147).
- 2.2 With respect to the Merchant Shipping (Minimum Standards) Convention, 1976 (ILO Convention No. 147), each Authority will be guided by the instructions in chapter 4 of the Asia-Pacific Port State Control Manual (hereinafter referred to as the "Manual"). The implementation of ILO Convention No. 147 will not require any alterations to structure or facilities involving accommodation for ships whose keels were laid down before April 1, 1994.
- 2.3 In the application of the other relevant instruments, each Authority will be guided by the standards specified in chapter 3 of the Manual.
- 2.4 Each Authority will apply those relevant instruments which are in force and are binding upon it. In the case of amendments to a relevant instrument each Authority will apply those amendments which are in force and which are binding upon it. An instrument so amended will then be deemed to be the 'relevant instrument' for that Authority.
- 2.5 In applying a relevant instrument for the purpose of port State control, the Authorities will ensure that no more favourable treatment is given to ships entitled to fly the flag of a non-party to that instrument.
- 2.6 When inspecting ships for provisions of the relevant instruments to which it is a Party, the Authority as the port State will not impose standards on foreign ships that are in excess of standards applicable to ships flying the flag of that port State.

Section 3 Inspection Procedures, Rectification and Detention

- 3.1 In implementing this Memorandum, the Authorities will carry out inspections, which will consist of at least a visit on board a ship in order to check the certificates and documents, and furthermore satisfy themselves that the crew and the overall condition of the ship, its equipment, machinery spaces and accommodation, and hygienic conditions on board, meets the provisions of the relevant instruments. In the absence of valid certificates, or if there are clear grounds for believing that the crew or the condition of the ship or its equipment does not substantially meet the requirements of a relevant instrument, or the master or crew are not familiar with essential shipboard procedure relating to the safety of ships or the prevention of pollution, a more detailed inspection will be carried out. Inspections will be carried out in accordance with the Manual.
- 3.2 Clear Grounds
- 3.2.1 The Authorities will regard as 'clear grounds' *inter alia* the following:
- .1 a report or notification by another Authority;
 - .2 a report or complaint by the master, a crew member, or any person or organization with a legitimate interest in the safe operation of the

ship, shipboard living and working conditions or the prevention of pollution, unless the Authority concerned deems the report or complaint to be manifestly unfounded; and

.3 other indications of serious deficiencies, having regard in particular to the Manual.

3.2.2 For the purpose of control, specific 'clear grounds' include those prescribed in paragraph 2.3 of IMO resolution A.787(19) contained in chapter 3 of the Manual.

3.2.3 Nothing in these procedures should be construed as restricting the powers of the Authorities to take measures within their jurisdiction in respect of any matter to which the relevant instruments relate.

3.3 In selecting ships for inspection the Authorities will give priority to the following ships:

.1 passenger ships, roll-on/roll-off ships and bulk carriers;

.2 ships which may present a special hazard, including oil tankers, gas carriers, chemical tankers and ships carrying harmful substances in packaged form;

.3 ships visiting a port of a State, the Authority of which is a signatory to the Memorandum, for the first time or after an absence of 12 months or more;

.4 ships flying the flag of a State appearing in the three-year rolling average table of above-average detentions published in the annual report of the Memorandum;

.5 ships which have been permitted to leave the port of a State, the Authority of which is a signatory to the Memorandum, on the condition that the deficiencies noted must be rectified within a specified period, upon expiry of such period;

.6 ships which have been reported by pilots or port authorities as having deficiencies which may prejudice their safe navigation;

.7 ships carrying dangerous or polluting goods, which have failed to report all relevant information concerning the ships' particulars, the ships movements and concerning the dangerous or polluting goods being carried to the competent authority of the port and coastal State;

.8 ships which have been suspended from their class for safety reasons in the course of the preceding six months;

.9 ships referred to in paragraph 3.9; and

.10 type of ships identified by the Committee (referred to in paragraph 6.3) from time to time as warranting priority inspections.

The Authorities will pay special attention to oil tankers and bulk carriers of 10 years of age and over.

- 3.4 The Authorities will seek to avoid inspecting ships which have been inspected by any of the other Authorities within the previous six months, unless they have clear grounds for inspection. The frequency of inspection does not apply to the ships referred to in paragraph 3.3, in which case the Authorities will seek satisfaction whenever they will deem this appropriate.
- 3.5 Inspections will be carried out by properly qualified persons authorized for that purpose by the Authority concerned and acting under its responsibility having regard to sections 2.4 and 2.5 of IMO resolution A.787(19) contained in chapter 3 of the Manual.
- 3.6 Each Authority will endeavour to secure the rectification of all deficiencies detected. On the condition that all possible efforts have been made to rectify all deficiencies, other than those referred to in 3.7, the ship may be allowed to proceed to a port where any such deficiencies can be rectified. The provisions of 3.8 apply accordingly.

In exceptional circumstances where, as a result of the initial control and a more detailed inspection, the overall condition of a ship and its equipment, also taking the crew and its living and working conditions into account, are found to be substandard, the Authority may suspend an inspection.

The suspension of the inspection may continue until the responsible parties have taken the steps necessary to ensure that the ship complies with the requirements of the relevant instruments.

Prior to suspending an inspection, the Authority will have recorded detainable deficiencies in the areas set out in Appendix 1 of IMO resolution A.787(19) and ILO Convention deficiencies*, as appropriate.

(* Examples of detainable deficiencies are set out in chapter 7 of the Manual.)

In cases where the ship is detained and an inspection is suspended, the Authority will, as soon as possible, notify the responsible parties. The notification will include information about the detention. Furthermore it shall state that the inspection is suspended until the Authority has been informed that the ship complies with all relevant requirements.

- 3.7 In the case of deficiencies which are clearly hazardous to safety, health or the environment, the Authority will, except as provided in 3.8, ensure that the hazard is removed before the ship is allowed to proceed to sea. For this purpose appropriate action will be taken, which may include detention or a formal prohibition of a ship to continue an operation due to established deficiencies which, individually or together, would render the continued operation hazardous. In the event of a detention, the Authority will as soon as possible, notify in writing the flag State or its consul or, in his absence, its nearest diplomatic representative of all the circumstances in which intervention was deemed necessary. Where the certifying Authority is an organization other than a maritime administration, the former will also be advised.
- 3.8 Where deficiencies which caused a detention as referred to in paragraph 3.7 cannot be remedied in the port of inspection, the Authority may allow the ship concerned to proceed to the nearest appropriate repair yard available, as chosen by the master and agreed to by the Authority, provided that the conditions determined by the Authority and agreed by the competent authority of the flag State are complied with. Such conditions will ensure that the ship can proceed without risk to the safety and

health of the passengers or crew, or risk to other ships, or without being an unreasonable threat of harm to the marine environment. In such circumstances the Authority will notify the Authority of the ship's next port of call, the parties mentioned in paragraph 3.7 and any other authority as appropriate. Notification to Authorities will be made in accordance with chapter 7 of the Manual. The Authority receiving such notification will inform the notifying Authority of action taken.

- 3.9 If a ship referred to in paragraph 3.8 proceeds to sea without complying with the conditions agreed to by the Authority of the port of inspection:
- .1 that Authority will immediately alert all other Authorities; and
 - .2 the ship will be detained at any port of the Authorities which have accepted the Memorandum, until the owner or operator has provided evidence to the satisfaction of the Authority of the port State, that the ship fully complies with all applicable requirements of the relevant instruments.

If a ship referred to in paragraph 3.8 does not proceed to the nominated repair port, the Authority of the repair port will immediately alert all other Authorities.

- 3.10 The provisions of this section are without prejudice to the requirements of relevant instruments or procedures established by international organizations concerning notification and reporting procedures related to port State control.
- 3.11 The Authorities will ensure that, on the conclusion of an inspection, the master of the ship is provided with a document, in the form specified in chapter 7 of the Manual, giving the results of the inspection and details of any action taken.
- 3.12 When exercising control under the Memorandum, the Authorities will make all possible efforts to avoid unduly detaining or delaying a ship. Nothing in the Memorandum affects rights created by provisions of relevant instruments relating to compensation for undue detention or delay.
- 3.13 In the case that an inspection is initiated based on a report or complaint, especially if it is from a crew member, the source of the information must not be disclosed.
- 3.14 The owner or the operator of a ship or its representative will have a right of appeal against a detention taken by the Authority of the port State. Initiation of the appeal process will not by itself cause the detention to be suspended.

Section 4 Provision of information

- 4.1 Each Authority will report on its inspections under the Memorandum and their results, in accordance with the procedures specified in the Manual.
- 4.2 Arrangements will be made for the exchange of inspection information with other regional organizations working under a similar memorandum of understanding.
- 4.3 The Authorities will, upon the request of another Authority, endeavour to secure evidence relating to suspected violations of the requirements on operational matters of Rule 10 of the International Regulations for Preventing Collisions at Sea, 1972 and the International Convention for the Prevention of Pollution from Ships, 1973, as modified by the Protocol of 1978 relating thereto. In case of suspected violations involving the discharge of harmful substances, an Authority will, upon the request of

another Authority, visit in port the ship suspected of such a violation in order to obtain information and, where appropriate, to take a sample of any alleged pollutant.

Section 5 Training Programs and Seminars

The Authorities will endeavour to establish training programs and seminars for port State control officers.

Section 6 Organization

- 6.1 A Committee composed of a representative of each of the Authorities that have accepted the Memorandum will be established. An observer from each of the International Maritime Organization, the International Labour Organization, the Economic and Social Commission for Asia and the Pacific and any other organization or authority which the Committee may deem appropriate will be invited to participate without vote in the work of the Committee.
- 6.2 The Committee will meet once a year and at such other times as it may decide.
- 6.3 The Committee will:
- .1 carry out the specific tasks assigned to it under the Memorandum;
 - .2 promote by all means necessary, including training and seminars, the harmonization of procedures and practices relating to inspection, rectification and detention whilst having regard to paragraph 2.4;
 - .3 develop and review guidelines for carrying out inspections under the Memorandum;
 - .4 develop and review procedures for the exchange of information; and
 - .5 keep under review other matters relating to the operation and the effectiveness of the Memorandum.
- 6.4 A Secretariat will be established in accordance with the following principles:
- .1 the Secretariat is a non-profit making body located in Tokyo;
 - .2 the Secretariat will be totally independent from any maritime administration or organization;
 - .3 the Secretariat will be governed by and be accountable to the Committee;
 - .4 the Secretariat will have a bank account into which all dues and contributions are made; and
 - .5 the Secretariat will operate from the established bank account in accordance with the budget determined by the Committee.
- 6.5 The Secretariat, acting under the guidance of the Committee and within the limits of the resources made available to it, will:

- .1 prepare meetings, circulate papers and provide such assistance as may be required to enable the Committee to carry out its functions;
 - .2 facilitate the exchange of information; and
 - .3 carry out such other work as may be necessary to ensure the effective operation of the Memorandum.
- 6.6 The Asia-Pacific Computerized Information System (APCIS) is established for the purpose of exchanging information on port State inspections, in order to:
- .1 make available to Authorities information on inspections of ships in other regional ports to assist them in their selection of foreign flag ships to be inspected and their exercise of port State control on selected ships; and
 - .2 provide effective information exchange facilities regarding port State control in the region.
- 6.7 The functions and operational procedures of the APCIS are specified in chapter 7 of the Manual.

Section 7 Amendments

- 7.1 The Memorandum will be amended by the following procedure:
- .1 any Authority that has accepted the Memorandum may propose amendments to the Memorandum;
 - .2 the proposed amendment will be submitted through the Secretariat for consideration by the Committee;
 - .3 amendments will be adopted by a two-thirds majority of the representatives of the Authorities present and voting in the Committee, each Authority exercising one vote. If so adopted an amendment will be communicated by the Secretariat to the Authorities for acceptance;
 - .4 an amendment will be deemed to have been accepted either at the end of a period of six months after adoption by the representatives of the Authorities in the Committee or at the end of any different period determined unanimously by the representatives of the Authorities in the Committee at the time of adoption, unless within the relevant period an objection is communicated to the Secretariat by an Authority;
 - .5 any such objection will be considered by the Committee at its next meeting, and the amendment will be confirmed if it is accepted by a two-thirds majority of the representatives of the Authorities present and voting in the Committee at such meeting. In these circumstances, a quorum of more than half of the total number of representatives of the Authorities that comprise the Committee is required. In the event that the amendment is confirmed, the date of its deemed acceptance will be either at the end of a period of six months after being confirmed or any different period determined unanimously by the representatives of the Authorities in the Committee at the time of confirmation; and

- .6 an amendment will take effect 60 days after it has been deemed accepted, or at the end of any different period of deemed acceptance as determined unanimously by the representatives of the Authorities in the Committee.
- 7.2 The Manual will be amended by the following procedure:
 - .1 the proposed amendment will be submitted through or by the Secretariat for consideration by the Authorities;
 - .2 the amendment will be deemed to have been accepted at the end of a period of three months from the date on which it has been communicated by the Secretariat unless an Authority requests in writing that the amendment should be considered by the Committee. In the latter case the procedure specified in paragraph 7.1 will apply; and
 - .3 the amendment will take effect 60 days after it has been accepted or at the end of any different period determined unanimously by the Authorities.

Section 8 Administrative Provisions

- 8.1 The Memorandum is without prejudice to rights and obligations under any international instrument.
- 8.2 Any maritime authority may, with the unanimous consent of the Authorities present and voting at the Committee meeting, adhere to the Memorandum. For such an Authority, the Memorandum will take effect upon such date as may be mutually determined.
- 8.3 Any maritime authority or organization wishing to participate as an observer will submit in writing an application to the Committee and will be accepted as an observer subject to the unanimous consent of the representatives of the Authorities present and voting at the Committee meeting.
- 8.4 Any Authority may withdraw from the Memorandum by providing the Committee with 60 days notice in writing.
- 8.5 The Memorandum is signed at Tokyo on December 1, 1993 and will remain open for signature until the signing during the first meeting of the Committee to be held in 1994.
- 8.6 The Memorandum will be available for acceptance from April 1, 1994, and will take effect for each Authority, which has signed the Memorandum, on the date its acceptance is duly notified to the Secretariat.
- 8.7 The English text is the official version of the Memorandum.

This Memorandum is signed at Tokyo on December 1, 1993 by the following Authorities:

Australia

New Zealand

Canada

Papua New Guinea

Fiji

Philippines

Hong Kong, China

Indonesia

Japan

Korea, Republic of

Malaysia

Russian Federation

Singapore, Republic of

Solomon Islands

Thailand

Vietnam, Socialist Republic of

This Memorandum is signed at Beijing on April 11, 1994 by the following Authorities:

China, People's Republic of

Vanuatu, Republic of

Note: The Memorandum contained herein is the text adopted on 1 December 1993 and amended on 13 August 1997 and 3 June 1998. The 1998 amendment is expected to take effect on 1 March 1999.

Appendix 3:

PSC FORMS

FORM A

REPORT OF INSPECTION IN ACCORDANCE WITH THE MEMORANDUM OF UNDERSTANDING ON PORT STATE CONTROL IN THE ASIA-PACIFIC REGION ¹⁾

**VIETNAM NATIONAL MARITIME BUREAU
(VINAMARINE)
11A Lang Ha, Hanoi, Vietnam
(telephone)
(facsimile)
(telegram)
(telex)**

**Copy head office
(surveyor's copy)
(master's copy)
(IMO copy)
(flag administration copy)**

- 1 name of issuing authority:
- 2 name of ship: 3 flag of ship:
- 4 type of ship:
- 5 call sign: 6 IMO number:
- 7 gross tonnage: 8 year of build:
- 9 date of inspection: 10 place of inspection:
- 11 relevant instruments and requirements:

(a) <u>relevant certificate</u>	(b) <u>issuing authority</u>	(c) <u>date of issue/expiry</u>
1
2
3
4
5
6
7
8

(d) the information below concerning the last survey shall be provided if the next survey is due or overdue

date	surveying authority	place
1
2
3
4
5
6
7
8

- 12 deficiencies no yes (see attached FORM B) SOLAS MARPOL
- 13 ship detained no yes
- 14 supporting documentation no yes (see annex)

district office name
duly authorised surveyor of VINAMARINE

telephone

facsimile/telegram..... signature.....

¹⁾ This inspection report has been issued solely for the purpose of informing the master and other Authorities that an inspection by the Authority, mentioned in the heading, has taken place. this inspection report cannot be as a seaworthiness certificate in excess of the certificate the ship is require to carry.

(reverse side of FORM B)

codes for action taken

code

- 00** no action taken
- 10** deficiency rectified
- 15** rectify deficiency at next port
- 16** rectify deficiency within 14 days
- 17** master instructed to rectify deficiency before departure
- 30** ship detained
- 35** detention raised
- 40** next port informed
- 50** flag administration/consul/maritime authority informed
- 55** flag administration/maritime authority consulted
- 60** regional authority informed
- 70** classification society informed
- 80** temporary substitution of equipment
- 85** investigation of contravention of discharge provisions (MARPOL)
- 99** other (specify in clear text)

Electr. exp. atm	C II-2 R 38/53/59	<input type="checkbox"/>	<input type="checkbox"/>
Electr. wirings/equipment	C II-1 R 45	<input type="checkbox"/>	<input type="checkbox"/>
Nos of two-way tel	C IV R 14-3	<input type="checkbox"/>	<input type="checkbox"/>
Freq. of two-way tel	C IV R 14-3	<input type="checkbox"/>	<input type="checkbox"/>
Valves in collision bulkhead	C II-1 R 11	<input type="checkbox"/>	<input type="checkbox"/>
WT doors pass. ship test	C II-1 R 24	<input type="checkbox"/>	<input type="checkbox"/>

ALARM

General alarm	C III R 50	<input type="checkbox"/>	<input type="checkbox"/>
UMS (EO) alarm	C II-1 R 47	<input type="checkbox"/>	<input type="checkbox"/>
Steering gear alarm	C II-1 R 29	<input type="checkbox"/>	<input type="checkbox"/>
Engineers alarm	C II-1 R 38	<input type="checkbox"/>	<input type="checkbox"/>
Inert gas alarm	C II-1 R 62	<input type="checkbox"/>	<input type="checkbox"/>
Boiler alarms	C II-1 R 32	<input type="checkbox"/>	<input type="checkbox"/>

ENGINE ROOM

Quick cl. valves	C II-2 R 15	<input type="checkbox"/>	<input type="checkbox"/>
Oily w. sep. 15 ppm	MARPOL	<input type="checkbox"/>	<input type="checkbox"/>
Alarm/stpping dev o.w.sep	MARPOL	<input type="checkbox"/>	<input type="checkbox"/>
Bilge pumps	C II-1 R 21	<input type="checkbox"/>	<input type="checkbox"/>
Prot. against noise	C II-1 R 36	<input type="checkbox"/>	<input type="checkbox"/>
Vent systs. E/R	C II-1 R 35	<input type="checkbox"/>	<input type="checkbox"/>
Mach. controls	C II-1 R 31,+ R 37/39	<input type="checkbox"/>	<input type="checkbox"/>
Steam boilers	C II-1 R 32	<input type="checkbox"/>	<input type="checkbox"/>
Heat oil boiler (Chem. tank)	BCH + IBC	<input type="checkbox"/>	<input type="checkbox"/>
Steam pipe syst	C II-1 R 33	<input type="checkbox"/>	<input type="checkbox"/>
Air press system	C II-1 R 26/34	<input type="checkbox"/>	<input type="checkbox"/>
Ox+Acet. bottles	C II-1 R 26	<input type="checkbox"/>	<input type="checkbox"/>
	C II-2 R14		
UMS(EO) -ship	+ C II-1 Part E	<input type="checkbox"/>	<input type="checkbox"/>

CREW - DRILLS

Last boat musteer	C III R 18	<input type="checkbox"/>	<input type="checkbox"/>
Last fire drill	C III R 18	<input type="checkbox"/>	<input type="checkbox"/>
Last launch lifeboat port	C III R 18	<input type="checkbox"/>	<input type="checkbox"/>
Last launch lifeboat stb	C III R 18	<input type="checkbox"/>	<input type="checkbox"/>
last davitlaunch liferafts	C III R 18	<input type="checkbox"/>	<input type="checkbox"/>
Training manual	C III R 51	<input type="checkbox"/>	<input type="checkbox"/>
Record of drills ets	C III R 18	<input type="checkbox"/>	<input type="checkbox"/>
Emergency steering drills	C III R 19-2	<input type="checkbox"/>	<input type="checkbox"/>
Muster list	C III R 8/53	<input type="checkbox"/>	<input type="checkbox"/>
Muster stations	C III R 24	<input type="checkbox"/>	<input type="checkbox"/>
Abandon and fire drills	C III R 25	<input type="checkbox"/>	<input type="checkbox"/>
Operational rediness	C III R 19	<input type="checkbox"/>	<input type="checkbox"/>
Posters	C III R 9	<input type="checkbox"/>	<input type="checkbox"/>
Embarkation arrange.	C III R 11/16	<input type="checkbox"/>	<input type="checkbox"/>
Recovery arrangement	C III R 15/16	<input type="checkbox"/>	<input type="checkbox"/>

GENERAL REMARKS

.....

.....

.....